

三菱电机放电加工机 消耗品目录



EDM Consumables



GLOBAL IMPACT OF MITSUBISHI ELECTRIC



三菱电机秉承“Changes for the Better”的企业经营理念，一如既往地打造更美好的明天。

Changes for the Better

三菱电机的业务范围涵盖了各个领域。

“Changes for the Better”意味着三菱电机集团「以追求更高更好为目标不断进行改革」的企业姿态。我们集团成员的每一个人都共享持续向改革挑战的坚强意志与热情、为开拓『更美好的明天』做担保。

能源、电力设备

从发电机到大型显示器的多样化电机产品

电子元件

应用于电力设备、电子产品等领域的尖端的半导体元器件

家电

空调、家庭娱乐系统等高信赖性的家电产品

信息通讯系统

适用于商务和个人的装置、机器、系统

工业自动化产品

基于e-F@ctory先进制造理念，以前沿的技术和丰富的控制、驱动、配电和加工机产品，提供节能增效综合解决方案

本公司的 AI 及 IoT 领域的进化发展，为包含自动化至信息系统的社会各方面带来了新的附加价值。创造改变传统机制的解决方案，推动全球变革，本公司的业绩得到认可，获得全球最具影响力的数字企业之一的评价，登上 2019 年福布斯全球“数字100强”榜。

OVERVIEW

电极丝	2
钻石导丝嘴	3~4&46
导电块	4&47
喷嘴	5-7&47-48
走丝周边装置	8~14&49~51
上部导丝部	15~20&52~53
下部导丝部	21~25&54~56
下部轮部	26-27&57
下部导丝套	28&56
下部绝缘板	29&58
丝回收装置	30-38&59-63
电极丝处理装置	39
过滤器(线切割)	40
RYODEN ION离子树脂	41
过滤器(电火花)	42
工具, 治具	43
电池, 润滑油	44
小孔加工机专用零件	45
电池, 显示器和键盘膜	64

Note:

- 1) Shown price are including V.A.T. and Import tax.
- 2) Shipping charges are not included.
- 3) Please understand that prices and other information are changeable without preview.



部件请详细参照细则，特殊型已经都做了注释，未做特别注释的属通用部件

电极丝 * 适合所有机型

名称	规格	型号	销售代码
 Non-Paraffin Brass Wire 无蜡铜丝 “Ryoden Cut III”	3kg/Reel, 0.1mm Dia.	RYODEN CUT III BRASS WIRE WIRE 0.1MM(3KG)	2210002967
	3kg/Reel, 0.15mm Dia.	RYODEN CUT III BRASS WIRE WIRE 0.15MM(3KG)	2210003333
	5kg/Reel, 0.2mm Dia.	RYODEN CUT III BRASS WIRE WIRE 0.2MM(5KG)	2210002425
	10kg/Reel, 0.2mm Dia.	RYODEN CUT III BRASS WIRE WIRE 0.2MM(10KG)	2210002426
	20kg/Reel, 0.2mm Dia.	RYODEN CUT III BRASS WIRE WIRE 0.2MM(20KG)	2210002427
	5kg/Reel, 0.25mm Dia.	RYODEN CUT III BRASS WIRE WIRE 0.25MM(5KG)	2210002428
	10kg/Reel, 0.25mm Dia.	RYODEN CUT III BRASS WIRE WIRE 0.25MM(10KG)	2210002429
	20kg/Reel, 0.25mm Dia.	RYODEN CUT III BRASS WIRE WIRE 0.25MM(20KG)	2210002430
	5kg/Reel, 0.3mm Dia.	RYODEN CUT III BRASS WIRE WIRE 0.3MM(5KG)	2210002431
	20kg/Reel, 0.3mm Dia.	RYODEN CUT III BRASS WIRE WIRE 0.3MM(20KG)	2210002432

名称	规格	型号	销售代码
 SP (Hybrid) Wire “SED Wire” 混合材料丝	5,000m/Reel, 0.05mm Dia.	XWREL-S0505	2210000084
	5,000m/Reel, 0.07mm Dia.	XWREL-S0705	2210000079

名称	规格	型号	销售代码
 高性能丝	5kg/Reel, 0.2mm Dia	RYODEN CUT S	2210004704
	5kg/Reel, 0.25mm Dia	RYODEN CUT S	2210004705

名称	规格	型号	销售代码
 镀锌丝	RYODEN CUT P 0.2 (5KG)	RYODEN CUT A	2210004960
	RYODEN CUT P 0.25(5KG)	RYODEN CUT A	2210004961
 高精度丝	RYODEN CUT P 0.2 (5KG)	RYODEN CUT P	2210004958
	RYODEN CUT P 0.25(5KG)	RYODEN CUT P	2210004959

导丝嘴 (标准)

* 适合[64]QA, FA, FA-S, FA-V, FA-VS, FA-P, FA-PS, PA

名称	规格	型号	销售代码
 Diamond Die Guide (U) 导丝嘴(上部)	0.1mm Dia.	X053C834G51	2210000585
	0.15mm Dia.	X053C834G52	2210000586
	0.2mm Dia.	X056C833G54	2210000592
	0.25mm Dia.	X056C833G55	2210000593
	0.3mm Dia.	X056C833G56	2210000594
 Diamond Die Guide (L) 导丝嘴(下部)	0.1mm Dia.	X052B243G63	2210000611
	0.15mm Dia.	X052B243G64	2210000609
	0.2mm Dia.	X052B387G54	2210000619
	0.25mm Dia.	X052B387G55	2210000620
	0.3mm Dia.	X052B387G56	2210000621

导丝嘴 (为用微细开始孔/高厚度)

* 以下属于特殊加工需要

名称	规格	型号	销售代码
 Diamond Die Guide (U) 导丝嘴(上部) *两个排列孔	0.03mm Dia.	X056C412G70	2210000605
	0.05mm Dia.	X056C412G51	2210000588
	0.07mm Dia.	X056C412G54	2210002334
	0.1mm Dia.	X056C412G55	2210002234
	0.15mm Dia.	X055C129G59	DCG9600
	0.2mm Dia.	X055C129G51	2210000599
	0.25mm Dia.	X055C129G52	2210000598
	0.3mm Dia.	X055C129G53	2210000600
 Diamond Die Guide (L) 导丝嘴(下部)	0.03mm Dia.	X052B243G73	2210000628
	0.05mm Dia.	X052B243G67	2210000613
	0.07mm Dia.	X052B243G66	2210002339
	0.36mm Dia.	X052B487G54	DAM3400
 Diamond Die Guide (L) 导丝嘴(下部) *为筒型导电块	0.03mm Dia.	X052B346G54	2210003283
	0.05mm Dia.	X052B346G53	2210000614
	0.07mm Dia.	X052B346G52	2210000626
	0.1mm Dia.	X052B346G51	2210000627

导丝嘴 (为15度以上锥加工)

名称	规格	型号	销售代码
 Diamond Die Guide (U) 导丝嘴(上部)	0.2mm Dia.	X059D986G51	2210000601
	0.25mm Dia.	X059D986G52	2210000602
 Diamond Die Guide (L) 导丝嘴(下部)	0.2mm Dia.	X059D987G51	2210000622
	0.25mm Dia.	X059D987G52	2210000623

导电块

名称	规格	型号	销售代码
 Power Feeder Die 导电块 *for SB,HA,SZ,SA, SX,CX,FX,FX-K,PX,RA,RA,FA,FA-S,FA-P,FA-PS,QA,PA series	Standard	X056C075H06 NTG0206	2210000756
 Power Feeder Die 导电块 *for FA-V & FA-VS series		X055C118H02	2210000758
 Power Feeder Die 导电块 *for BA series		X088D493H02	2210000763
 Power Feeder Die 导电块 *for PA series	For 0.05-0.1mm Dia. Wire	X054D476H01	2210000768
 Power Feeder Die 导电块 *for PA series	For 0.03-0.04 Dia. Wire	X058D489H01	2210000759

喷嘴 (标准)

★ 适合[64]QA, FA, FA-S, FA-V, FA-VS, FA-P, FA-PS, PA

名称	规格	型号	销售代码
 Flushing Nozzle (U) 喷嘴(上部)	4mm Dia.	X056C836H01	2210000677
 Flushing Nozzle (D) 喷嘴(下部)	4mm Dia.	X054D881H07	2210000689 (陶瓷) 2210004334 (塑料)

喷嘴 (为15度以下锥加工/高速加工)

★ 适合[64]QA, FA, FA-S, FA-V, FA-VS, FA-P, FA-PS, PA

名称	规格	型号	销售代码
 Flushing Nozzle (U) 喷嘴(上部)	8mm Dia.	X056C836H02	2210000680
 Flushing Nozzle (D) 喷嘴(下部)	8mm Dia.	X054D881H08	2210000690

喷嘴 (为15度以上锥加工)

★ 适合[64]QA, FA, FA-S, FA-V, FA-VS, FA-P, FA-PS, PA

名称	规格	型号	销售代码
 Flushing Nozzle (U) 喷嘴(上部)	20mm Dia.	X253C007H01	2210000707
 Flushing Nozzle (D) 喷嘴(下部)	16mm Dia.	X260D820H01	2210000706

喷嘴 (为PAM option)

★ 适合[64]QA, FA, FA-S, FA-V, FA-VS, FA-P, FA-PS, PA

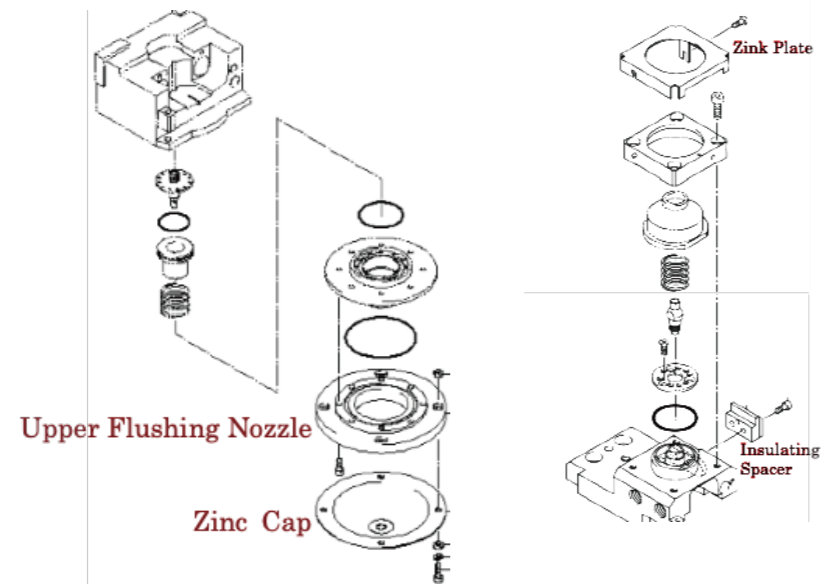

名称	规格	型号	销售代码
Flushing Nozzle (U) 喷嘴(上部)	4mm Dia.	X203C929H01	2210000679
Zinc Cap (U) 锌盖子(上部)		X264D883H01	2210000720
Flushing Nozzle (U) 喷嘴(上部)	8mm Dia.	X203C929H02	2210000681
Zinc Cap (U) 锌盖子(上部)		X264D757H01	2210000722
Zinc Plate (D) 锌盖子(下部)		X259D536H01	2210000718
Insulating Spacer 下部锌盖子专用垫片		X259D473G52	2210001455

喷射嘴





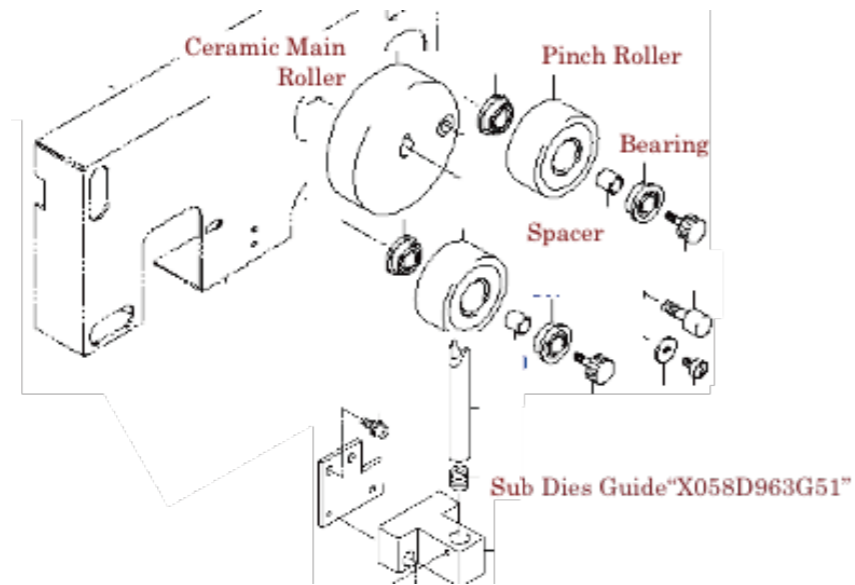

★ 适合[64]QA, FA, FA-S, FA-V, FA-VS, FA-P, FA-PS, PA

名称	规格	型号	销售代码
Jet Nozzle 喷射嘴	0.75mm Dia.	X054D826H07	2210000697
Jet Nozzle 喷射嘴	1.5mm Dia. (Standard)	X058D054H02	2210000695
Jet Nozzle 喷射嘴	2.0mm Dia.	X054D826H11	2210003734
Jet Nozzle 喷射嘴	2.5mm Dia.	X054D826H12	2210000700
O-Ring O型圈		S932N420P20	2210000848
Vinyl Cover 塑料盖子	CO-0612A	X179D943H03	2210000438
Vinyl Cover 塑料盖子 *for RA series	190x61mm Dia.	X199D297H04	2210000456

走丝周边装置

★ 适合FA, FA-S, FA-P, FA-PS, FA-V, FA-VS, PA20

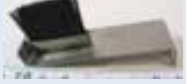

名称	规格	型号	销售代码
 Main Tension Roller 主张力轮子(陶瓷)		X055C683G51	2210000332
 Pinch Roller (Urethane) 主张力夹轮子(胶皮)	Standard	X088D350G52	2210000325
 Bearing 轴承	DDRF-1980DDR	S859N319P31	2210002271
 Pinch Roller (Ceramic) 主张力夹轮子(陶瓷) *for High-speed machining Wires	Option	X058D998H01	2210000320
 Collar 垫片		X264D518H01	2210000650
 Sub Guide Die 补助骰子	1.0mm Dia.	X088D339G51	2210001443
 Brush 毛刷		X088D274G51	2210000223

走丝周边装置

★ 适合BA, FA-S Adv., FA-PS Adv.系列

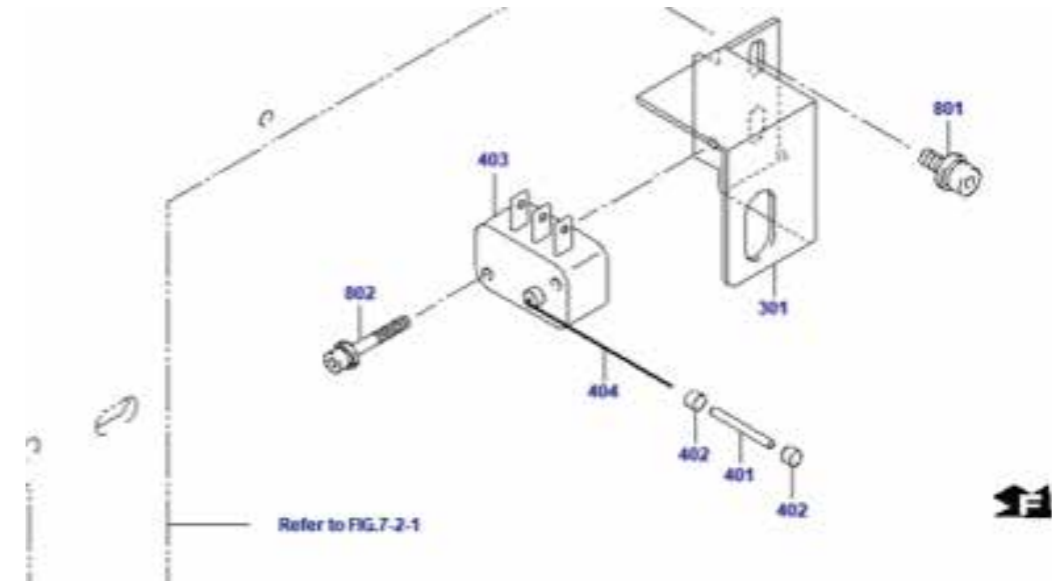



名称	规格	型号	销售代码
 Micro Switch	D2MC-01ELA	P421A030P00	2210001249
 Actuator Lever	CAA1M	P421A021P00	2210001284
 Insulation Tube		X054D027H02	2210000006
 Rubber Stopper		X174D527H01	2210000086
 Bakelite Plate (B) 夹板		X088D533H01	2210003036
 Felt Cleaner 过滤毡	50mm Dia.	X088D534H01	2210001746
 Bakelite Plate (F) 夹板		X178D933H03	2210000713
 Pulley		X262D338H01	2210003243
 Bearing	F689ZZ1MC3	P840F000P71	2210000192

走丝周边装置

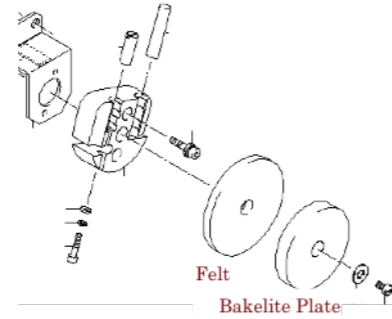
★ 适合FA, FA-S, FA-V, FA-VS, FA-P, FA-PS系列



名称	规格	型号	销售代码
 Felt Cleaner 过滤毡	70mm Dia.	X059D050H03	2210001743
 Bakelite Plate 夹板		X059D051H03	2210000721

走丝周边装置

★ 适合FA-S, FA-V, FA-VS, FA-PS系列

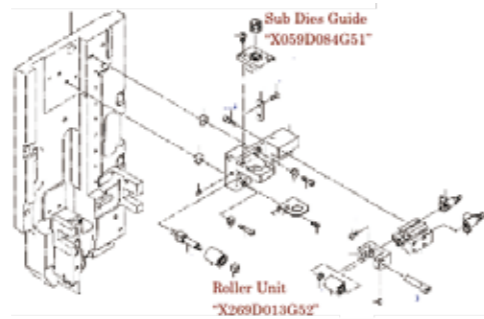



名称	规格	型号	销售代码
 Sub Guide Dies 补助骰子	0.5mm Dia.	X059D084G51	2210000107
 Roller Unit AT夹轮子 *1台机床需要配备2套	D14mmxL18mm	X269D013G52	2210000309
 Air Cylinder 汽缸	D6xL5mm	P663K000P58	2210000033

走丝周边装置

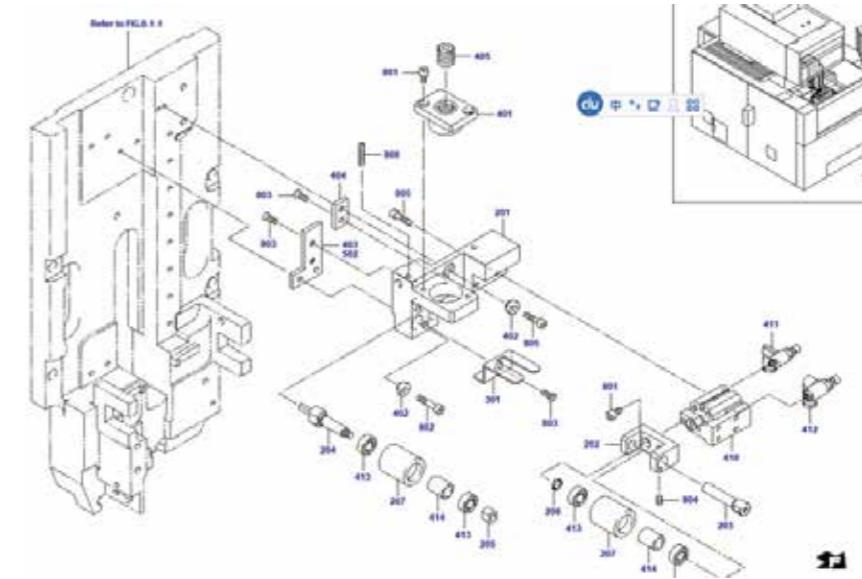
★ 适合FA-S Adv., FA-PS Adv., BA8系列



名称	规格	型号	销售代码
 Sub Guide Dies 补助骰子	0.2mm Dia.	X059D084G51	2210000107
 Roller AT夹轮子	D18xL21mm	X261D421H01	2210000326
 One-way Clutch 离合器		S811N724P12	2210002262
 Bearing 轴承		P840K001P74	2210000207
 Collar 垫片		X261D544H01	2210003944
 Air Cylinder 汽缸	D6xL5mm	P663K000P58	2210000033

走丝周边装置

★ 适合PA20系列

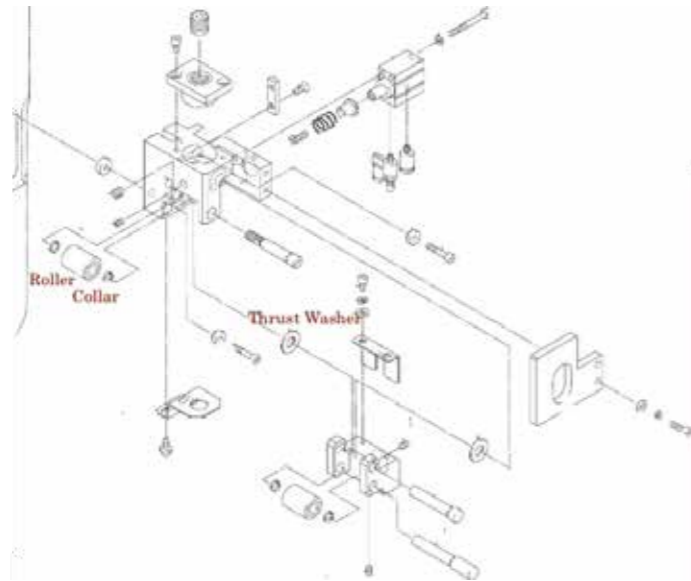



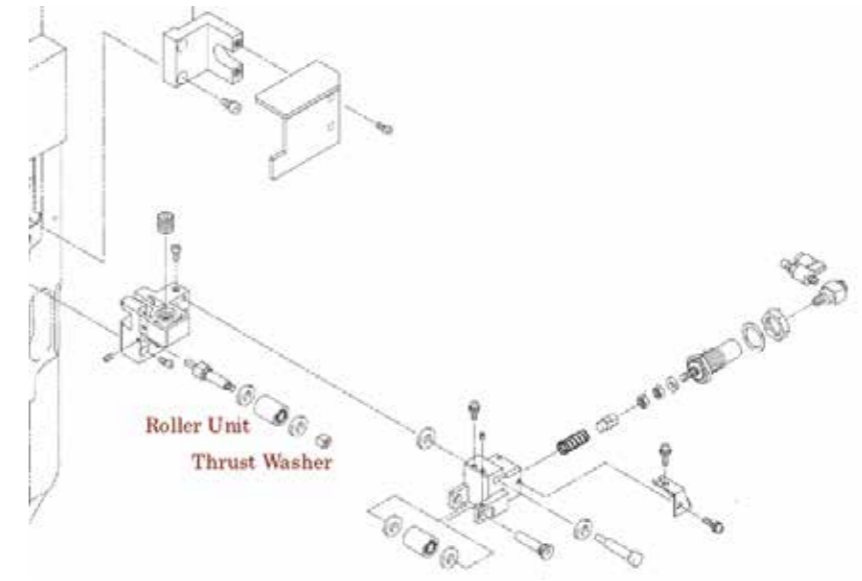

	名称	规格	型号	销售代码
	Sub Guide Dies 补助骰子	0.2mm Dia.	X059D084G51	2210000107
	Roller Unit AT夹轮子	D14mmxL18mm	X269D013G52	2210000309
	Thrust Washer	R-TW0603	S836N415P01	2210001473
	Air Cylinder 汽缸	D10xL10mm	P663K000P02	2210000044

走丝周边装置

★ 适合FA-P, FA-V系列

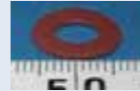



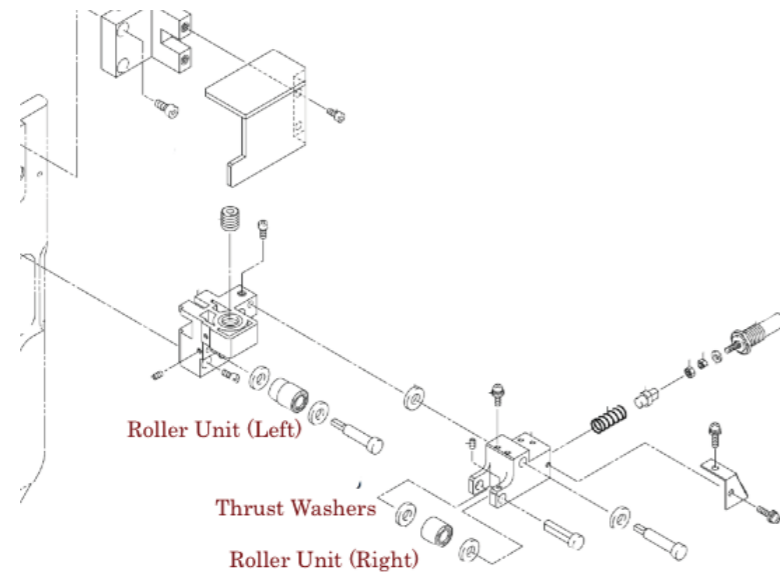

	名称	规格	型号	销售代码
	Sub Guide Dies 补助骰子	0.2mm Dia.	X059D084G51	2210000107
	Roller Unit AT夹轮子 *2 sets required for a machine	D14mmxL18mm	X269D013G52	2210000274
	Thrust Washer	R-TW0603	S836N415P01	2210001473
	Air Cylinder 汽缸	D10xL10mm	S663N118P25	2210000021

走丝周边装置

★ 适合FA系列







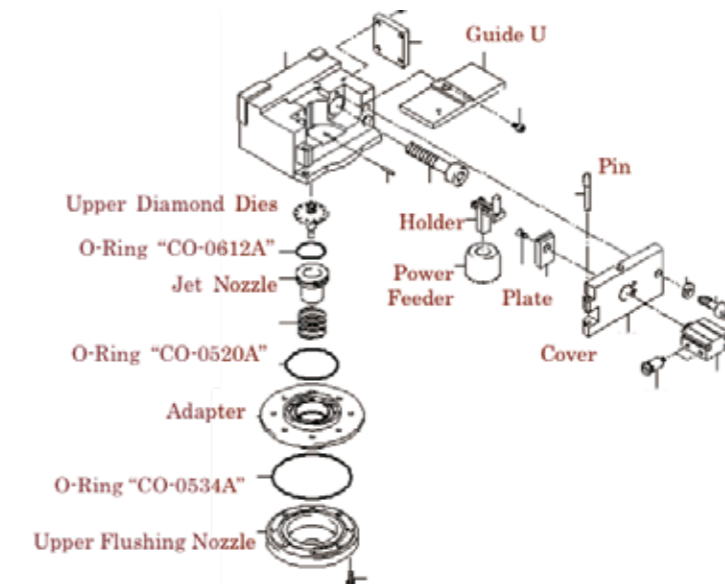

名称	规格	型号	销售代码
 Sub Guide Dies 补助骰子	0.2mm Dia.	X059D084G51	2210000107
 Roller Unit (Left) AT夹轮子(左边) *RA(#1-12), FA10(#1-21), FA20(#1-37)		X058D991G52	2210000301
 Roller Unit (Right) AT夹轮子(右边) *RA(#1-12), FA10(#1-21), FA20(#1-37)		X058D991G51	2210000302
 Thrust Washer	R-TW0603	S836N415P01	2210001473
 Air Cylinder 汽缸	D6xL10mm	P656F000P15	2210003406

上部导丝部

★ 适合FA-S/PS Adv., FA-S/P/V, FA系列 和PA20共用



名称	规格	型号	销售代码
 O-Ring O型圈	CO-0612A	S932N420P20	2210000848
 O-Ring	CO-0520A	S932N421P21	2210000850
 O-Ring	CO-0534A	S932N421P35	2210000849
 Compression Coil Spring 压缩发条		X927D278H01	2210000260
 Nozzle Adapter 上部喷嘴柄		X187B370H03	2210001532
 Hex Socket Bolt 螺丝	M3X8(SUS)(10pcs)	S903N229P04	2210003081

上部导丝部

★ 适合FA-S/PS Adv., FA-S/P/V, FA系列 和PA20共用

	名称	规格	型号	销售代码
	Guide U 上部补助导丝股子	0.4mm Dia.	X055C763G51	2210000995
	Pin 导电块定位销	H7-2x20mm H7, 2x10mm	P921K001P73 P921K001P20	2210001632 2210001627
	Hook 钩子		X059D448G52	2210000716
	Flat Head Screw 平头螺丝	P-SUS304-SA 3X8(10pcs)	S900N142P08	2210002984
	Pushing Plate 上部导电块压板		X268D104H01	2210000719
	Air Cylinder 汽缸		X055C667G51	2210000034
	Bolt 螺丝	SUS-ANA M3X30	PACBLT0335	2210003799
	Union Socket 气接头		P648F002P36	2210001803
	Float Switch 浮子开关		S649D899P14	2210001253

上部导丝部





★ 适合BA24和BA8 (制造编号DB#178以后)

	名称	规格	型号	销售代码
	O-Ring O型圈	CO-0520A	S932N421P21	2210000850
	Nozzle Adapter 上部喷嘴柄		X192B673H02	2210003561
	O-Ring O型圈	CO-0534A	S932N421P35	2210000849
	Guide U 上部补助导丝股子		X055C631G53	2210003565
	Slide Sheet 乙烯膜		X088D415H01	2210003546
	Air Cylinder 汽缸	D10xL6mm	P663K000P84	2210003567
	Union Socket 气接头		P648F002P36	2210001803
	DIE HOUSING(U) 上机头		X255C252H02	2210003083
	NOZZLE BASE 上机头底座		X253C936H02	2210003027

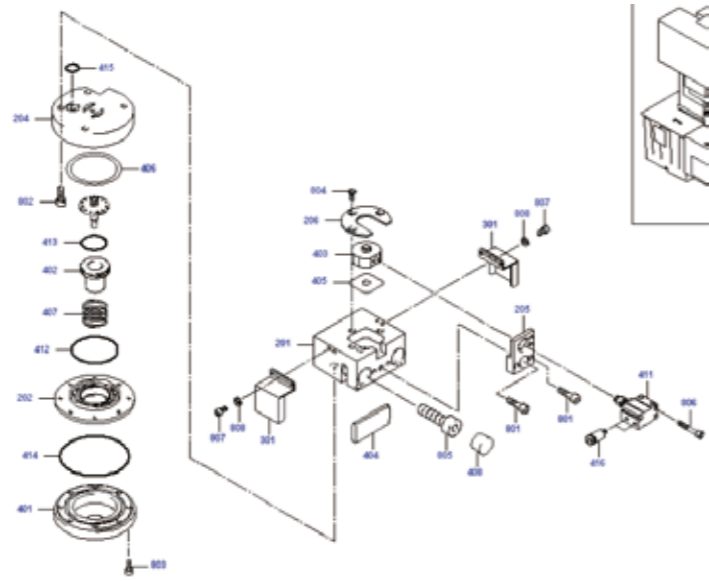
上部导丝部



★ 适合BA8 (制造编号DB#1-177)



	名称	规格	型号	销售代码
	O-Ring O型圈	CO 0505A	S932N421P06	2210000863
	Packing 垫圈		X088D495H01	2210003877
	Compression Coil Spring 压缩发条		X927D278H01	2210000260
	O-Ring O型圈	CO-0520A	S932N421P21	2210000850
	Nozzle Adapter 上部喷嘴柄		X192B673H02	2210003561
	O-Ring O型圈	CO-0534A	S932N421P35	2210000849

上部导丝部

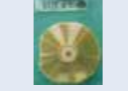
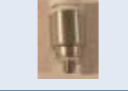
★ 适合BA8 (制造编号DB#1-177)

	名称	规格	型号	销售代码
	Guide Support 向导盖		X262D037H03	DBQ1900
	Guide U 上部补助导丝股子		X055C631G52	2210000994
	Slide Shee 乙烯膜		X088D415H01	2210003546
	Air Cylinder 汽缸	D10xL6mm	P663K000P84	2210003567
	Union Socket 气接头		P648F002P36	2210001803
	DIE HOUSING(U) 上机头		X253C935H01	2210001111
	NOZZLE BASE 上机头底座		X253C936H02	2210003027

上部导丝部

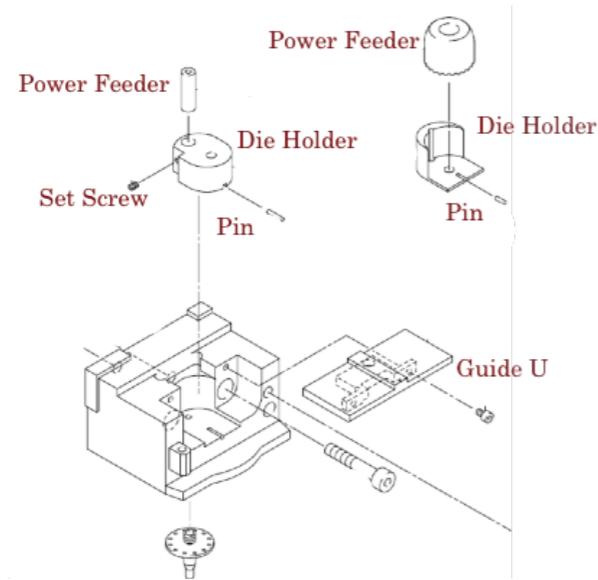

★ 适合PA05 和PA05S共用





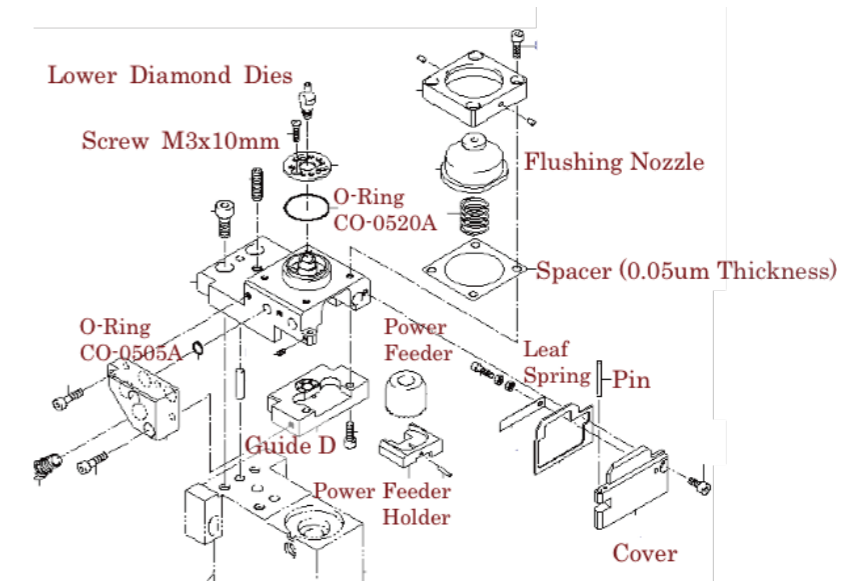



下部导丝部

★ 适合FA-S/PS Adv., FA-S/P/V, FA, RA系列 和PA20共用



	名称	规格	型号	销售代码
	Die Holder 上部导电块夹		X254D530H02	2210001115
	Set Screw 无头螺丝	TOMME, M3x4mm SUS-ANA-TOMEM3X4 (10pcs)	停产 S901N329P01 代替品S901N329P01	2210001406 D640200
	Pin 导电块定位销	SUS-HEIKOO H7-2X10	P921K001P20	2210001627
	Die Holder 导电块座		X260D963H02	2210001112
	Pin 导电块定位销	H7, 2x6mm	P921K001P30	2210001636
	Guide U 上部补助导丝骰子		X055C424G51	2210000993

	名称	规格	型号	销售代码
	Counter-sunk Head Screw 螺丝	P-SUS304-SA M3X10(10pcs)	S900N142P10	2210002985
	O-Ring O型圈	*for Lower Flushing Nozzle	S932N421P21 CO-0520A	2210000850
	O-Ring O型圈	*for Hydro Circuit Adapter	S932N421P06 CO 0505A	2210000863
	Guide (D) 下部导丝骰子	0.4mm Dia. (Standard)	X053C884G63 (X053C884G52)	2210000996 (2210000970)
	Guide (D) 下部导丝骰子	0.8mm Dia. (FA-V, V package Op.)	X053C884G55	2210000974
	Guide (D) 下部导丝骰子	1.2mm Dia. (0.36mm Wire Op.)	X055C342G51	DAM3300
	Holder 导电块座		X261D452H01	2210000625
	Straight Pin 导电块定位销	D2xL.10 mm	P921K001P20	2210001627

下部导丝部

★ 适合FA-S/PS Adv., FA-S/P/V, FA, RA系列 和PA20共用

	名称	规格	型号	销售代码
	Nozzle Holder		X208D528H02	221000088
	Compression Coil Spring 压缩发条		X927D266H01	2210000258
	Spacer 下部喷嘴垫片	0.05um Thickness	X209D179H01	2210001451
	Leaf Spring Plate 导电块压板		X054D943H01	2210000259
	Cover 下部导电块盖子		X205C102G51	2210002931

下部导丝部





★ 适合BA8 (制造编号DB#178以后) 和BA24

	名称	规格	型号	销售代码
	Nozzle Support 下喷嘴框		X262D095H03	2210002988
	Pin 定位销	SUS SPRING D3xL6mm	S921N313P06	2210001621
	Compression Coil Spring 压缩发条		X927D266H01	2210000258
	Spacer 垫片		X262D184H01	2210001463
	O-Ring O型圈	*for Hydro Circuit Adapter	S932N421P06 CO 0505A	2210000863
	Connector 液接头	C4N8 PT1/8	S648N411P24	2210000769
	DIE HOUSING(D) 下机头		X255C335H01	2210001127
	GUIDE(D)HOUSING 下机头底座		X262D527H01	2210001128
	GUIDE(D) 下机头导向座		X055C798G54	2210003082

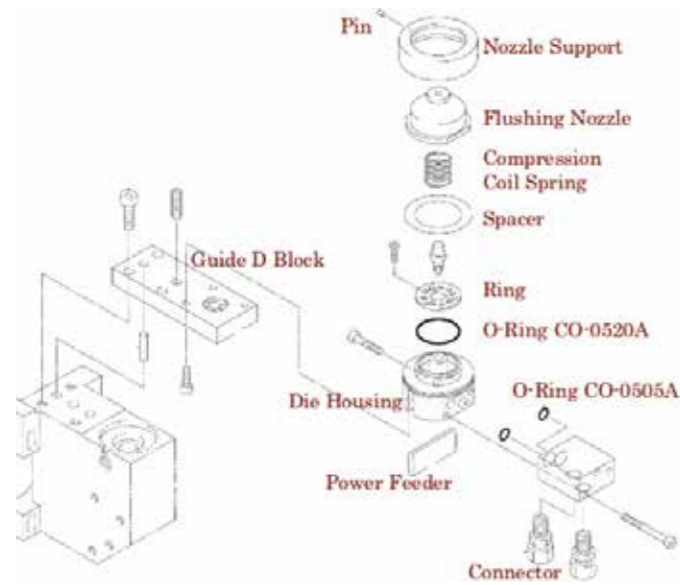
下部导丝部

★ 适合BA8 (制造编号DB#1-177)





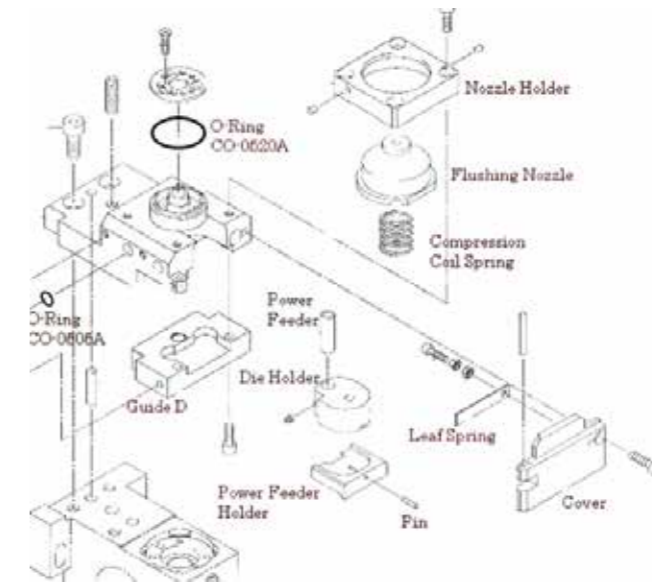

	名称	规格	型号	销售代码
	Guide D Block 下部导丝块		X055C630G54	2210000992
	Nozzle Support 喷嘴固定座		X262D095H03	2210002988
	Pin 定位销	SUS SPRING D3xL6mm	S921N313P06	2210001621
	Spacer 垫片		X262D184H01	2210001463
	O-Ring O型圈	for Hydro Circuit Adapter	S932N421P06 CO 0505A	2210000863
	Connector 液接头	C4N8 PT1/8	S648N411P24	2210000769
	DIE HOUSING(D) 下机头		X253C989H02	2210004477
	GUIDE(D) 下机头底座		X055C630G54	2210000992

下部导丝部

★ 适合PA05, PA05S系列



	名称	规格	型号	销售代码
	Counter-sunk Head Screw 螺丝	P-SUS304-SA M3X10(10pcs)	S900N142P10	2210002985
	O-Ring O型圈	*for Lower Flushing Nozzle	S932N421P21 CO-0520A	2210000850
	O-Ring O型圈	*for Hydro Circuit Adapter	S932N421P06 CO 0505A	2210000863
	Guide (D) 下部导丝块	0.4mm Dia. (Standard)	X055C478G51	2210002933
	Die Holder (D) 下部导电块夹		X258D633H01	2210001114
	Power Feeder Holder 导电块座		X258D634H02	2210001116

下部轮部

★ 适合FA-S/PS Adv., BA, FA-S/P/V, FA, RA系列 和PA05, PA20共用

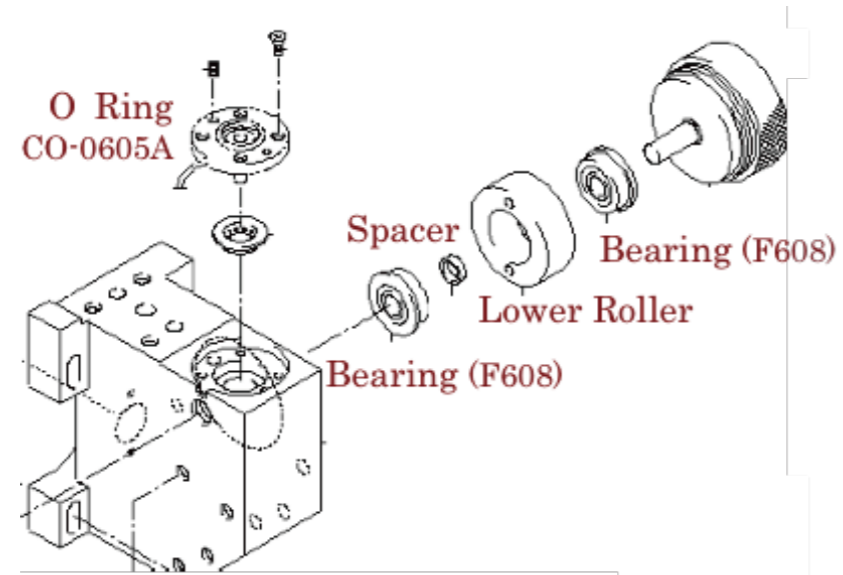

名称	规格	型号	销售代码
Aspirator 吸引器(丝通过检查器)		X053C920G51A	2210001209
Screw 螺丝	P-SUS304-SAM3X10(10pcs)	S900N142P10	2210002985
Lower Roller 下部轮		X203C607H03	2210000290
Bearing 轴承	适用 $\leq 0.15\text{mm}$ 适用 $\geq 0.20\text{mm}$	F608-H-VVMC3 NS7S F608-H-DDMC3	2210002306 2210003260
Spacer 垫片		X264D237H01	2210000649
Cable 电缆	RSF-V (14sq.MM)	X942Z144H00	2210001003

下部轮部

★ 适合PA05S

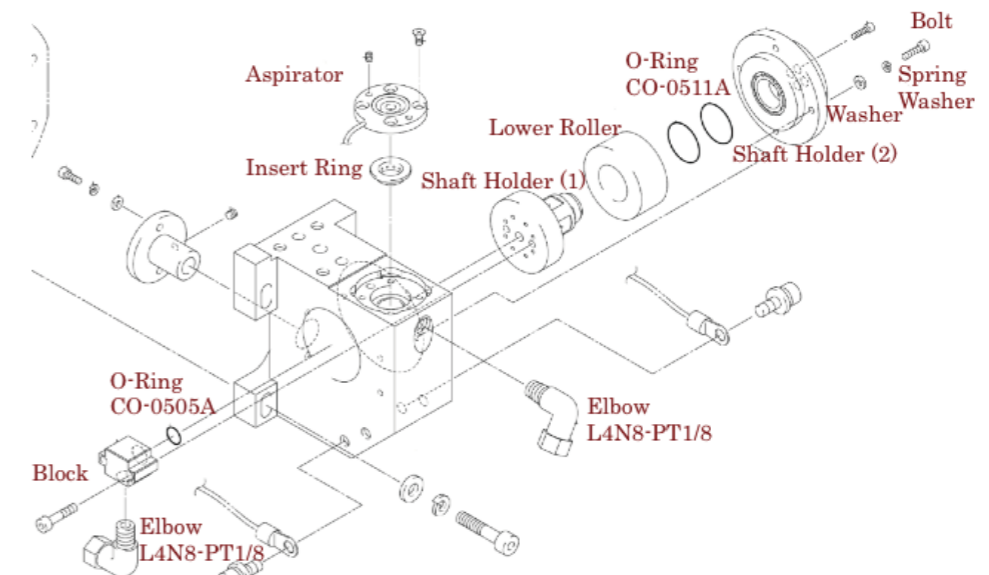

名称	规格	型号	销售代码
Rectifying Ring 整流环		X194D998H02	2210000839
Lower Roller 下部轮		X055C364H01	2210000328
Shaft Holder (1) 轴支座 (1)		X192B395H01	2210001117
Shaft Holder (2) 轴支座 (2)		X192B396H01	2210001118
O-Ring O型圈	*for Shaft Holder	S932N421P12 CO-0511A	2210000870
O-Ring O型圈	*for Block	S932N421P06 CO 0505A	2210000863
Elbow 液接头	L4N8-PT1/8	S648N412P14	2210002267

下部导丝套

	名称	规格	型号	销售代码
	for FA-S/PS & FA-S/PS Adv. series		X187B621H01+X181A788G71	D511600
	for FA series		X187B621H01+X181A788G51	2210000997
	for FA-V series		X658B083G85+X181A788G71	
	for PA05		X636A476G61+X658B153G51	





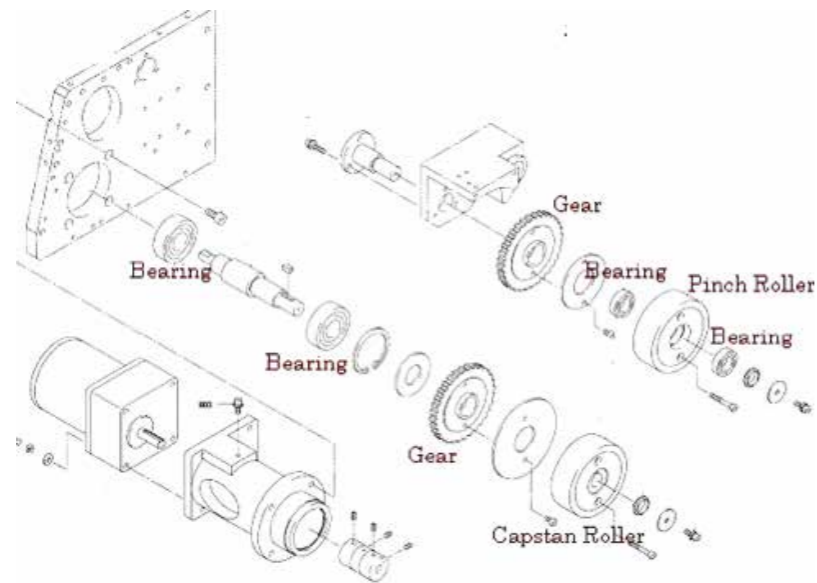

下部绝缘板

	名称	规格	型号	销售代码
	Insulating Plate (Lower) 绝缘板(下部) *for BA, FA-S Adv., FA-PS Adv., FA-S, FA-PS, FA-VS, FA20P, FA10D, FA10V, FA20V, FA30V, PA20, RA		X056C356G53	2210001165
	Insulating Plate (Lower) 绝缘板(下部) *for FA20, FA20V, FA20P, FA30		X056C356G52	2210001164
	Insulating Plate (Lower) 绝缘板(下部) *for PA05, PA05S, FA10P, FA10		X056C968G51	2210001163

丝回收装置 (向上废丝)

★ 适合FA-S Adv., FA-PS Adv.系列 和BA系列共用



	名称	规格	型号	销售代码
	Pinch, Wire Collection Roller 丝回收轮(夹侧)		X085C556G51	2210004529
	Bearing 轴承(夹侧)	6902-H-20T1XZZ1*MA NS7S	P840K002P36	2210000203
	Collar 树脂隔板		X088D451H01	2210001461
	Capstan, Wire Collection Roller 丝回收轮(马达侧)		X085C557G51	2210004530
	Bearing 轴承(马达侧)	6204LLUCM/5K	P840K000P25	2210000204
	GAER 齿轮		X088D449H02	2210001074

丝回收装置 (向上废丝)

★ 适合FA-S Adv., FA-PS Adv.系列 和BA系列共用

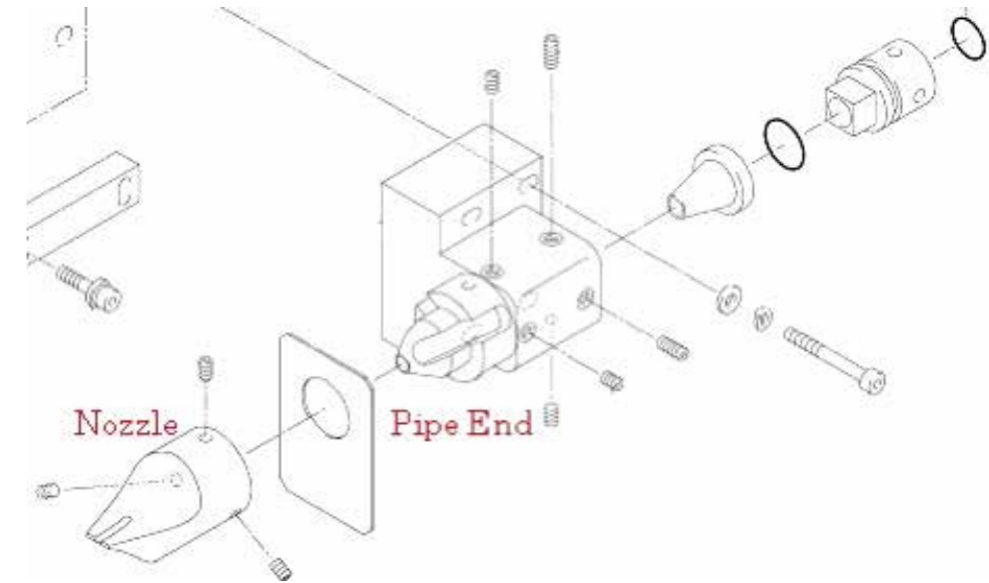

	名称	规格	型号	销售代码
	Pipe End 导丝管端		X052B539G51	2210001199
	Pipe End Nozzle 导丝管嘴		X088D442G52	2210000708

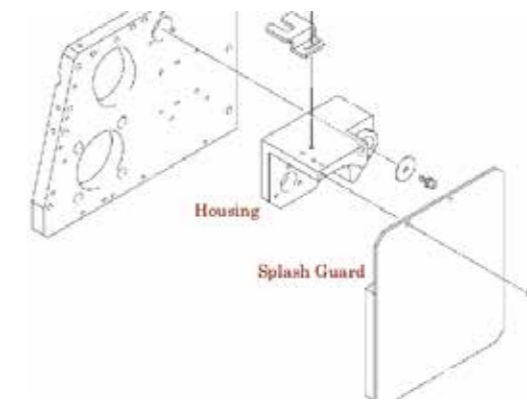







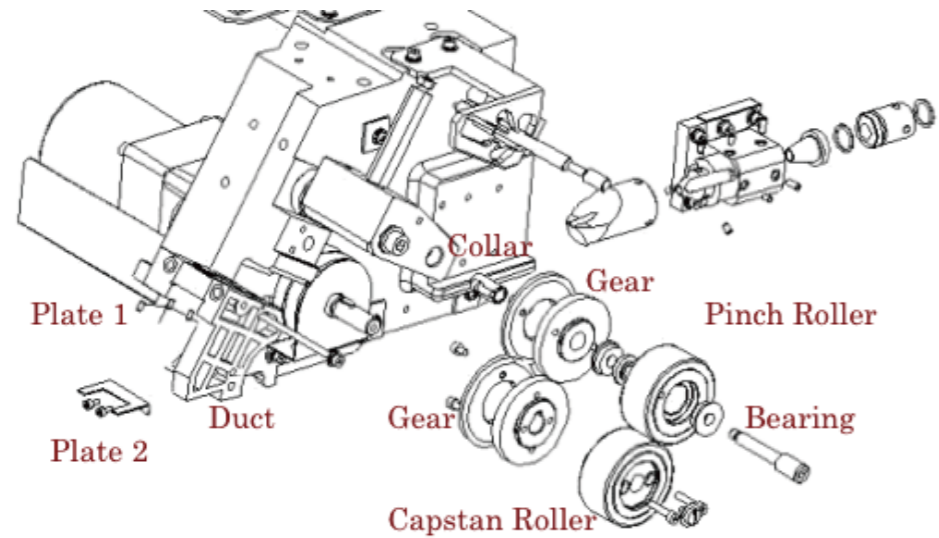

	名称	规格	型号	销售代码
	Housing 套子		X253C860N51	DEP1500
	Splash Guard 挡水板		X088D519G51	2210004125

丝回收装置(向上废丝)

★ 适合FA, FA-S, FA-V, FA-VS, FA-P, FA-PS系列 和FA20(#281-)共用



	名称	规格	型号	销售代码
	Pinch, Wire Collection Roller 丝回收轮(夹侧)		X055C008G51	2210000300
	Bearing 轴承(夹侧)		S859N319P31 DDRF-1980DDR POP25LY121	2210002271
	Collar 垫片 *Spare for missing		X269D069H01	2210000656
	Capstan, Wire Collection Roller 丝回收轮(马达侧)		X055C009G51	2210000299
	Bearing 轴承(马达侧)		S862N033P10 6203ZZCM/5K	2210002278
	Gear (Common for both rollers) 齿轮(上下共用)		X058D501H01	2210001068
	Pipe End 导丝管端		X052B399G51	2210001183
	Pipe End Nozzle 导丝管嘴		X059D299G51	2210000704

丝回收装置(向上废丝)

★ 适合FA, FA-S, FA-V, FA-VS, FA-P, FA-PS系列 和FA20(#281-)共用

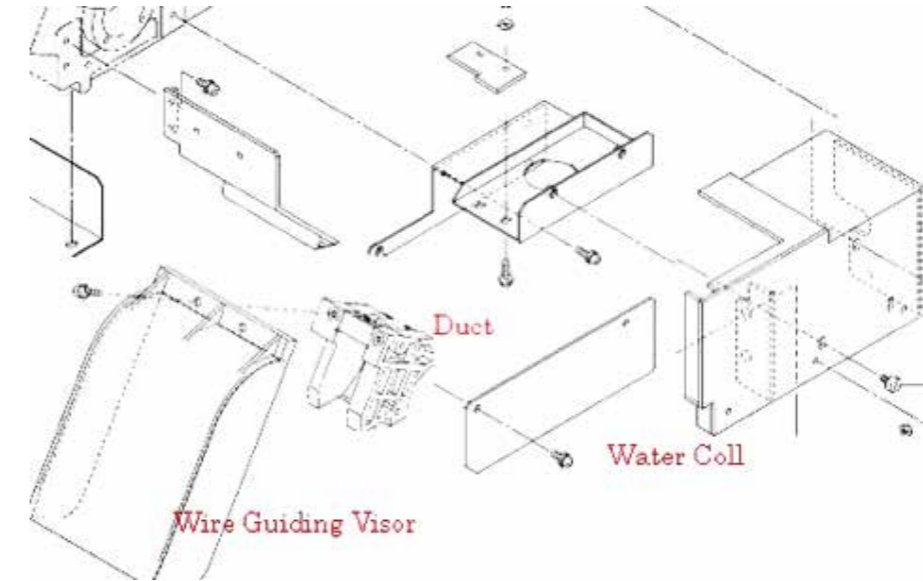

	名称	规格	型号	销售代码
	Wire Guiding Visor 废丝案内板		X059D446H01	2210000978
	Duct 废丝输出管		X052B449G52	2210000751
	Water Collection Cover 水回收套		X055C067G51	2210000448

丝回收装置(向上废丝)

★ 适合PA05系列和QA系列

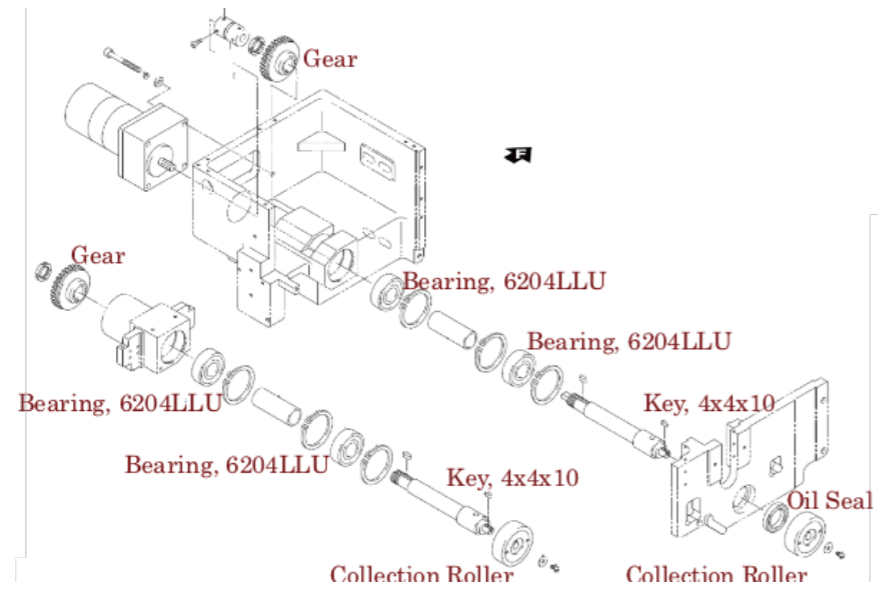



	名称	规格	型号	销售代码
	Gear 齿轮(上下共用)		X088D725G51	2210002759
	Wire Collection Roller 丝回收轮(上下共用)		X058D339G51	2210000288
	Bearing 轴承(四个共用)		P840K000P25	2210000204
	Key 楔子	4x4x10mm	S925Z610H01	2210001750
	Oil Seal 密封圈	AE1467E0	P932F000P19	2210002307

丝回收装置(向上废丝)

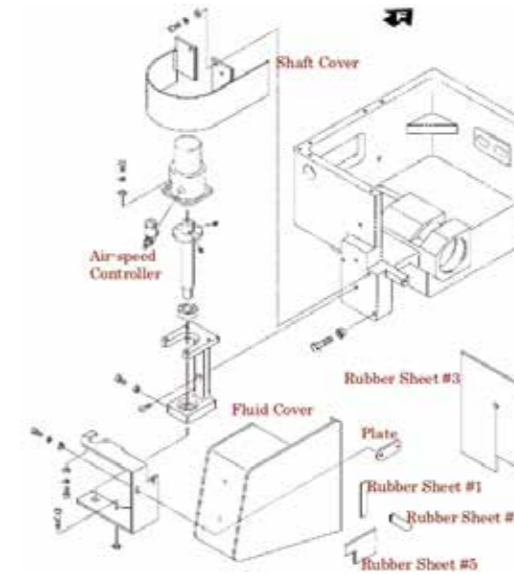
★ 适合PA05系列和QA系列



	名称	规格	型号	销售代码
	Shaft Cover		X058D861G51	2210003519
	Air-speed Controller	SC6-M5-MA	P662K001P23	2210003520
	Fluid Cover		X187B428G51	2210000071

丝回收装置(向上废丝)

★ 适合PA05系列和QA系列

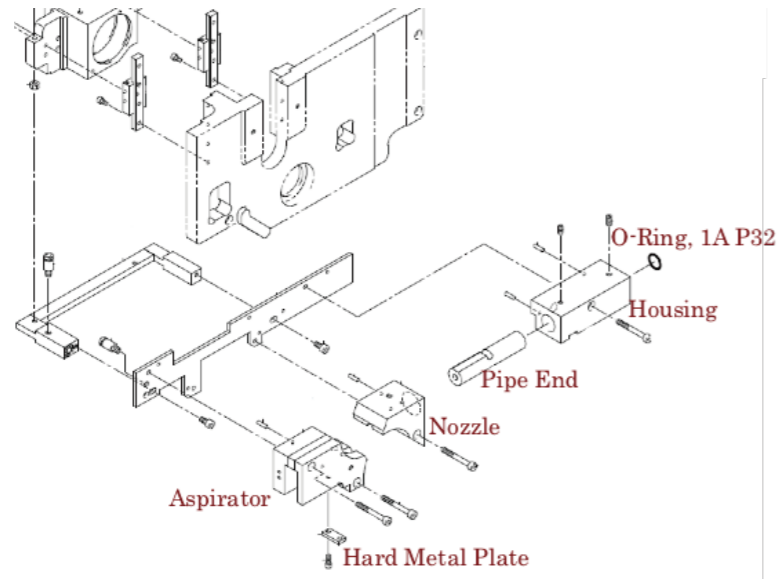

名称	规格	型号	销售代码
Aspirator 标准		X052B384G51	2210001372
为0.03mm Dia.以下		X649D266G51	D632300
Hard Metal Plate		X058D948H01	DH71400
Nozzle		X055C068H01	D630500

丝回收装置(向下废丝)

★ 适合RA系列 和FA20(#1-280)共用

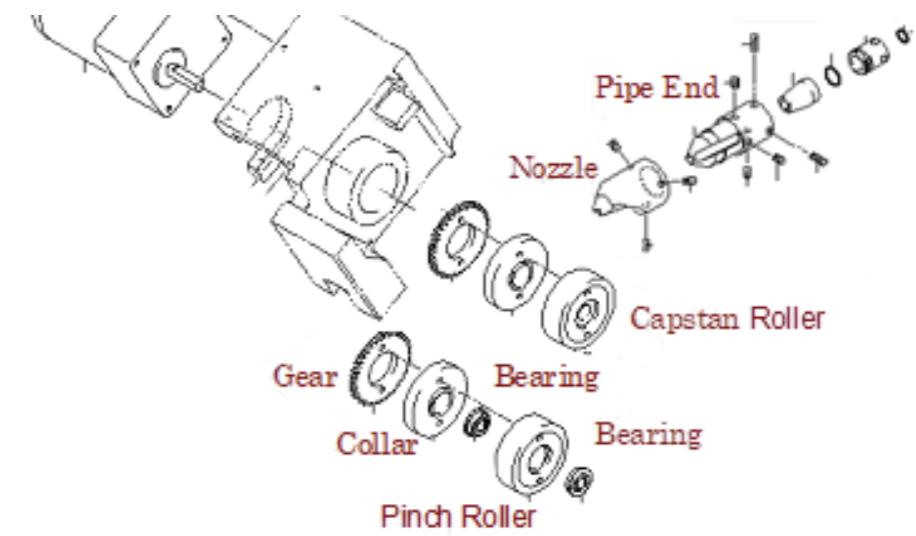

名称	规格	型号	销售代码
Pinch, Wire Collection Roller 丝回收轮(夹侧)		X058D340G51	2210000287
Bearing 轴承(夹侧)		S859N319P31 DDR-1980DDR	2210002271
Capstan, Wire Collection Roller 丝回收轮(马达侧)		X058D339G51	2210000288
Bearing 轴承(马达侧)		S862N033P10 6203ZZCM/5K	2210002278
Gear (Common for both rollers) 齿轮(上下共用)		X058D501H01	2210001068

■ 丝回收装置 (向下废丝)

★ 适合FA20(#1-280)

	名称	规格	型号	销售代码
	Pipe End 导丝管端		X056C948G51	2210001181
	Pipe End Nozzle 导丝管嘴		X059D019G51	2210000702
	Water Collection Cover 水回收套 *for FA20 (#1-180)		X059D234G51	2210000454





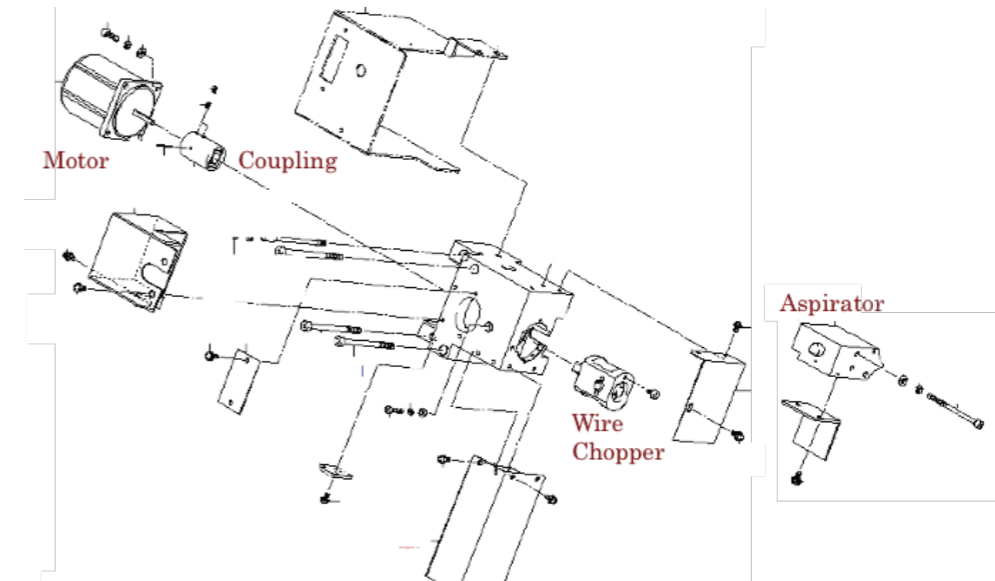

■ 丝回收装置 (向下废丝)

★ 适合RA系列 和FA20(#1-280)共用

	名称	规格	型号	销售代码
	Pipe End 导丝管端		X056C864G51	2210001177
	Pipe End Nozzle 导丝管嘴		X059D019G51	2210000702
	Water Collection Cover 水回收套 *for RA series		X205C106G51	2210000455

■ 电极丝处理装置



	名称	规格	型号	销售代码
	Wire Chopper 电极丝处理装置 *Fixed Blade (X058D370H01) is equipped		S684D888P33	2210000641
	Fixed Blade 固定刀		X058D370H01	2210000638
	Aspirator 废丝输出管		X055C078H02	2210002368
	Coupling 联轴器 *Rubber (X258D168H05) is equipped		X258D168G57	DDV7500
	Rubber 联轴器橡胶		X258D168H05	2210000008
	Motor 电极丝处理马达	M71X15S4LG	X055C959H01	2210003628





■ 过滤器 (线切割专用)

	名称	规格	型号	销售代码
	Filter Element 过滤器 Ryoden Filter II *适合[32]CX, FX, FX-K, PX *适合[64]RA, QA, FA, FA-S, FA-V, FA-VS, FA-P, FA-PS, PA, BA, NA, MV	Standard Mesh		2210004507
	Filter Element 过滤器 TYPE200 *适合[32]CX, FX, FX-K, PX *适合[64]RA, QA, FA, FA-S, FA-V, FA-VS, FA-P, FA-PS, PA, BA, NA, MV	Standard Mesh	S642D854P14	2210004759
	Coupler for type 50 接头(为type 50) *Spare for missing *O-Ring Equipped	1 piece	XFLAR-A09101	2210001537
	Air Filter for Unit Cooler 过滤器(为冷却单元) *for Unit Cooler "HE-SV50			2210001398

■ 离子交换树脂 (线切割专用)

	名称	规格	型号	销售代码
	Ion Exchange Resin 离子交换树脂	5 Liters/bag		2210002975
	Ion Exchange Resin 离子交换树脂 (硬质合金加工专用)	5 Liters/bag		2210003537
	RYODEN ION 适用所有机型			
	Line Filter 水管里过滤器		X418C619G51	2210000801
	Couplers are included	推荐H-10 CASE ONLY (不含树脂)	S644D839P24A	2210003384
	Coupler (Inlet for Hose) 接口(管入口)		XPRWT-H10B	2210000488
	Coupler (Outlet for Hose) 接口(管出口)		XPRWT-H10C	2210000492
	Coupler (Inlet for Bottle) 接口(桶入口)		XPRWT-H10D	2210000491
	Coupler (Outlet for Bottle) 接口(桶出口)		XPRWT-H10E	2210000489
	Bottle Cap 盖子		CAP FOR H-10	2210000487

■ 过滤器 (电火花专用)



	名称	规格	型号	销售代码
	Filter Element 过滤器 *for EA & VA series	Standard Mesh	S642D854P11 Super X	2210000789
	Filter Element 过滤器 *for EA & VA series *for MA (#1-24)	High Mesh	S642D854P11H0 Super X	2210000796
	Filter Element 过滤器 *for EA-V, EA-P, EA-PV, EA-A EA-V Adv. & EA-PV Adv. series *for MA (#25-)	High Mesh	P642K001P30 YM9	2210000798
	Packing (门) 密封条(EA&FA)		S642D897P65 10X20X5R-EX	2210001042

■ 工具, 治具

	名称	规格	型号	销售代码
	Wire Alignment Device 找垂直器 *适合[32]HA, SA, SX, CX, FX, FX-K, PX *适合[64]RA, QA, FA, FA-S, FA-V, FA-VS, FA-P, FA-PS, PA	Standard	S684D844P68(A)	2210001001
		High Precision	S684D848P76 3R-220.3	2210002126
	Rust Removing Liquid 浓缩洗涤剂	6Liters/bottle	HYP-R1S	2210004031
	Rust Remove Solution 除锈液	6Liters/bottle	HYP-R2S	2210004032
	Rust 防锈剂	6Liters/bottle	HYP-AD3	2210004033
	防锈喷雾剂	420ml/bottle	HYP-ECC	2210004034
	淤渣清洗剂	420ml/bottle	HYP-SFC	2210004049
	导丝嘴清洗剂	300ml/bottle	HYP-DGC	2210004346
	Guide Dies Fixing Tool 导丝嘴固定工具 *Supported Angle Master op		X260D821N51	2210001702
	Power Feeder Alignment Jig 导丝块固定工具		X644C301G51	DBU8200

■ 电池

★ 适合RA, QA, FA, FA-S, FA-V, FA-VS, FA-P, FA-PS, PA, EA, VA, MA

	名称	规格	型号	销售代码
	Lead-Acid Battery 铅蓄电池 *for UPS	PXL12050	P280K000P39	2210003073
	Lithium Cell Battery 锂离子电池 *for Servo Amp "MDS-SVJ2"	MR-BAT	TC350A013G51	2210004894
	Lithium Cell Battery 锂离子电池 *for CNC or Servo Amp "MDS-R-V2"	ER6V	P280A054P00	2210000146

■ 润滑油

★ 适合所有机型

	名称	规格	型号	销售代码
	Grease Gun 加黄油器	KH-120	S689N210P01	2210000003

■ 小孔加工机(MEMH8)专用消耗品

	名称	规格	型号	销售代码
	Pipe Electrode 电极管	0.3mm Dia./L300mm		2210002221
		0.5mm Dia./L300mm		2210002220
		0.8mm Dia./L300mm		2210002219
		1.5mm Dia./L300mm		2210002218
		2.0mm Dia./L300mm		2210002217
	Electrode Guide 导管嘴 *2pcs Packing attached	0.2mm Dia.	XMH-GUD02	2210001815
		0.3mm Dia.	XMH-GUD03	2210001806
		0.4mm Dia.	XMH-GUD04	2210001823
		0.5mm Dia.	XMH-GUD05	2210001807
		0.6mm Dia.	XMH-GUD06	2210001816
		0.7mm Dia.	XMH-GUD07	2210001808
		0.8mm Dia.	XMH-GUD08	2210001804
		1.0mm Dia.	XMH-GUD10	2210001809
		1.5mm Dia.	XMH-GUD15	2210001810
		2.0mm Dia.	XMH-GUD20	2210001811
		3.0mm Dia.	XMH-GUD30	2210001812
			Electrode Guide Packing 垫圈	0.2mm Dia./2pcs
0.3-0.4mm Dia./2pcs	XMH-MMEHP04			2210001814
0.5-0.8mm Dia./2pcs	XMH-MMEHP06			2210001805
0.9-1.1mm Dia./2pcs	XMH-MMEHP09			2210001817
1.2-1.4mm Dia./2pcs	XMH-MMEHP12			2210001818
1.5-2.0mm Dia./2pcs	XMH-MMEHP15			2210001819
2.1-2.4mm Dia./2pcs	XMH-MMEHP21			2210001820
2.5-2.7mm Dia./2pcs	XMH-MMEHP26			2210001821
2.8-3.0mm Dia./2pcs	XMH-MMEHP28			2210001822
	Filter Element 过滤器	Original Standard RF-H010	XFL-RFH010	2210003952
	Filter Element 过滤器 *Plastic Chassis	High Mesh D340xH300mm	Type 50M	2210000794
	Condensed Working Fluid 浓缩加工液	MME-H10 (10L)	XMH-MME10	2210001777

■ 导丝嘴 (标准)

★ 适合[64] MV, MX

名称	规格	型号	销售代码
Diamond Die Guide (U) 导丝嘴(上部)	0.05mm Dia.	X052B662G58	2210004000
	0.07mm Dia.	X052B662G76	2210004798
	0.1mm Dia.	X052B662G65	2210004004
	0.15mm Dia.	X052B662G64	2210004006
	0.2mm Dia.	X052B662G63	2210004008
	0.25mm Dia.	X052B662G62	2210004010
	0.3mm Dia.	X052B662G61	2210004012
Diamond Die Guide (D) 导丝嘴(下部)	0.05mm Dia.	X052B663G58	2210004001
	0.07mm Dia.	X052B663G76	2210004389
	0.1mm Dia.	X052B663G65	2210004005
	0.15mm Dia.	X052B663G64	2210004007
	0.2mm Dia.	X052B663G63	2210004009
	0.25mm Dia.	X052B663G62	2210004011
	0.3mm Dia.	X052B663G61	2210004013

■ 导丝嘴 (为15度以上锥加工)

名称	规格	型号	销售代码
Diamond Die Guide (U) 导丝嘴(上部)	0.2mm Dia.	X052B664G63	2210004731
	0.25mm Dia.	X052B664G62	2210004607
Diamond Die Guide (L) 导丝嘴(下部)	0.2mm Dia.	X052B665G63	2210004732
	0.25mm Dia.	X052B665G62	2210004608

■ 导电块

★ 适合[64] MV

名称	规格	型号	销售代码
Power Feeder Die 导电块		X089D256H02	2210003148

■ 喷嘴 (标准)

★ 适合[64]MV

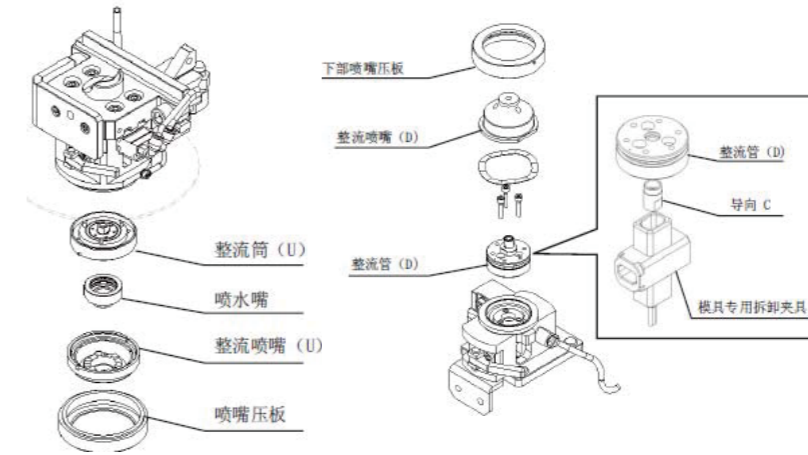

名称	规格	型号	销售代码
Flushing Nozzle (U) 整流喷嘴U(上部)	4mm Dia.	X085C257H01	2210003568
Flushing Nozzle (D) 整流喷嘴D(下部)	4mm Dia.	X085C131H11	2210003328

■ 喷嘴 (为15度以下锥加工/高速加工)

名称	规格	型号	销售代码
Flushing Nozzle (U) 整流喷嘴U(上部)	7mm Dia.	X085C257H02	2210003920
Flushing Nozzle (D) 整流喷嘴D(下部)	7mm Dia.	X085C131H12	2210003560

■ 喷嘴 (为15度以上锥加工)

名称	规格	型号	销售代码
Flushing Nozzle (U) 整流喷嘴U(上部)	20mm Dia.	X085C576H01	2210004615
Flushing Nozzle (D) 整流喷嘴D(下部)	16mm Dia.	X085C575H01	2210004616

■ 喷射嘴

★ 适合[64]MV

名称	规格	型号	销售代码
Jet Nozzle 喷射嘴	SIZE:0.3mm		2210004482
	SIZE:0.5mm	X089D300H01	2210002921
Jet Nozzle 喷射嘴	SIZE:0.7mm	X089D300H02	2210002922
Jet Nozzle 喷射嘴	1.0mm Dia	X089D300H03	2210002923
Jet Nozzle 喷水嘴	1.5mm Dia. (Standard)	X089D279H01	2210002882
O-Ring O型圈	CO-0517A *NOK	S932N421P18	2210002883
Vinyl Cover 塑料盖子			

■ 走丝周边装置

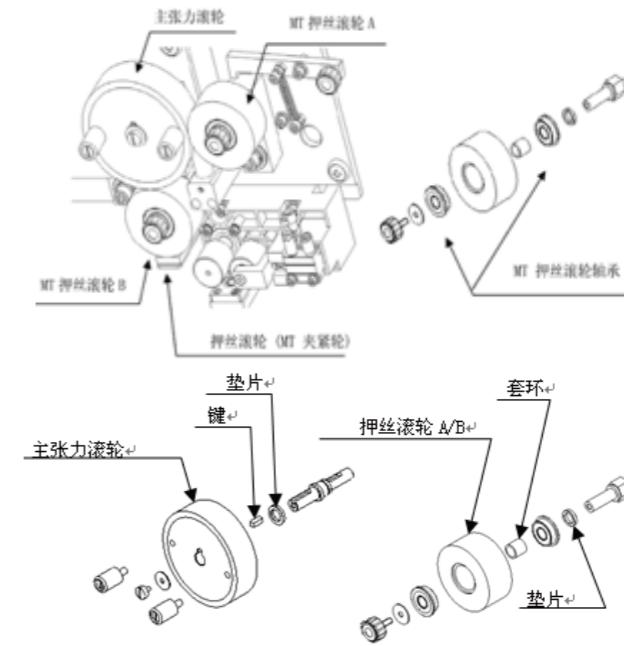

★ 适合[64]MV

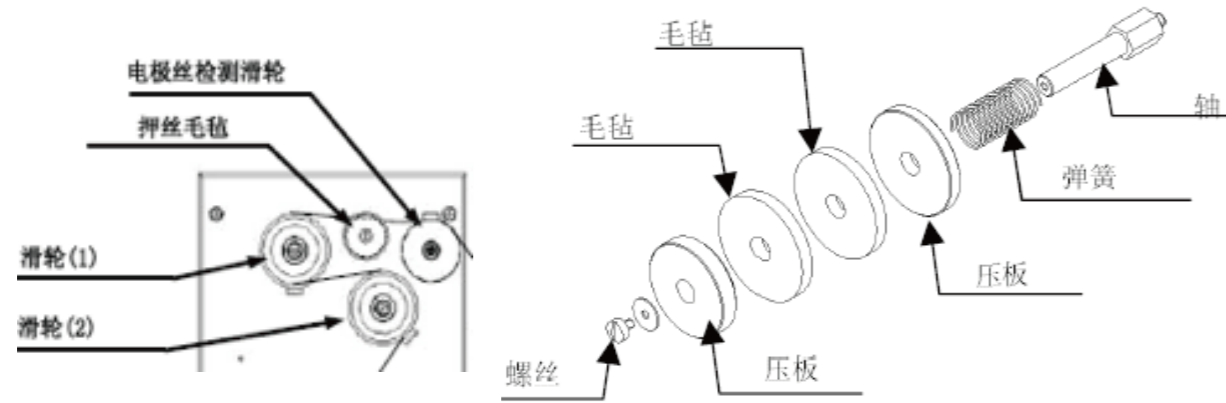

名称	规格	型号	销售代码
 Main Tension Roller 主张力轮子(胶皮)		X089D051G51	2210002892
 Pinch Roller (Urethane) 主张力夹轮子(陶瓷)	Standard	X088D301H04	2210004711
 Bearing 轴承	DDRF-1980DDR	P0P25LY121	2210002271
 Collar2 套环 *Spare for missing		X264D518H01	2210000650

走丝周边装置





名称	规格	型号	销售代码
 Felt Cleaner 毛毡	50mm Dia.	X088D534H01	2210001746
 Bakelite Plate (F) 压板		X178D933H03	2210000713

走丝周边装置

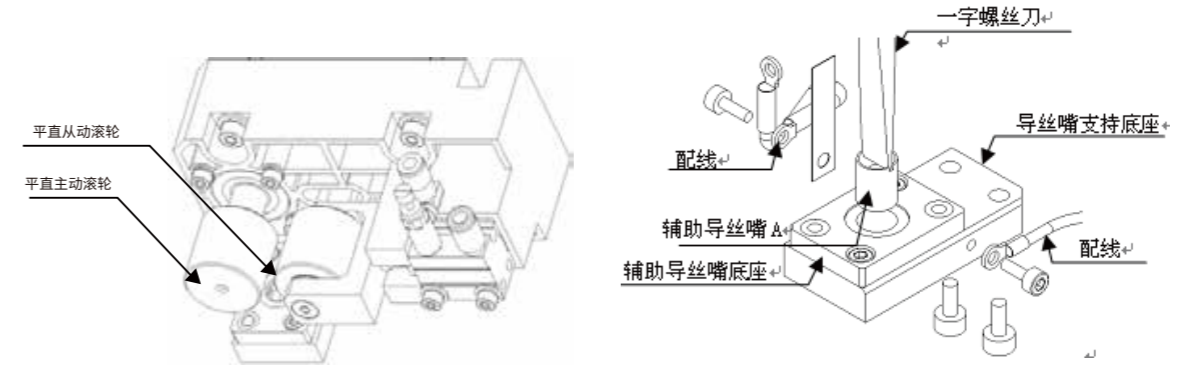
* 适合[64]MV

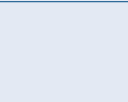
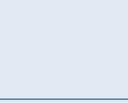

名称	规格	型号	销售代码
 Auxiliary Die 辅助导丝嘴A		X085C542G51	2210004690
 Toughening Roller 平直主动滚轮		X274D892H01	2210003479
 Toughening Roller(22D) 平直从动滚轮(22D)		X263D558H01	2210003480
 Cylinder 汽缸	CUJB6-10DM D6xL5mm	P663K017P50	2210002908

上部导丝部

★ 适合[64]MV

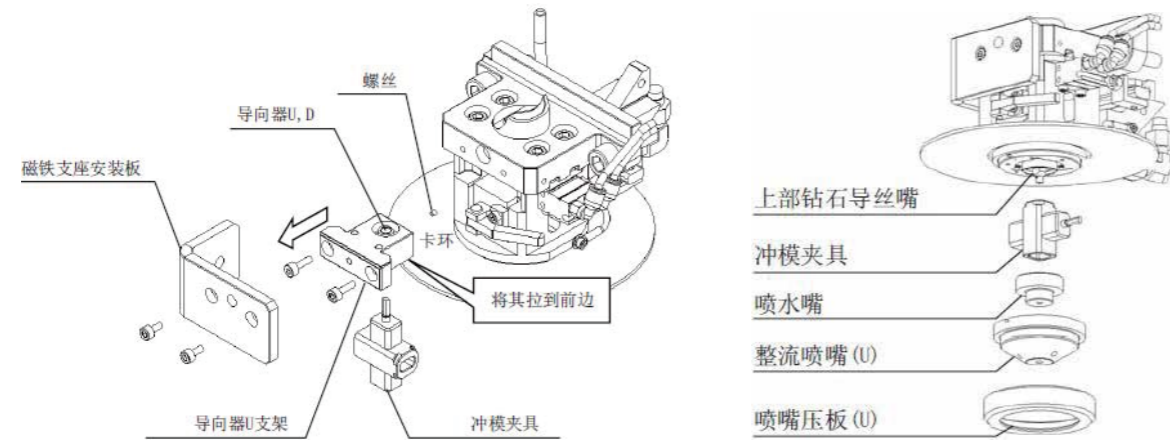

名称	规格	型号	销售代码
 Nozzle 导向器U支架	4mm Dia.	X085C257H01	2210003568
 Guide (UD) 导向器底座		X085C079G53	2210002876
 Bearing 铜丝导向器	MR126JZMC3 PS2S	P840K001P74	2210000207
 ONE WAY CLUTCH 滚针轴承	HF0612 AT	S811N724P12	2210002262
 BRAKE ROLLER 夹丝自动轮	CUJB10-8DM	X085C147G52	2210003728
 Air Cylinder 汽缸		P663K017P58	2210002919
 Pushbar 塑料安装板		X089D220H02	2210003255
 Block 固定座		X191A801G52	2210003468
 Base 固定座		X197B296H02	2210003467
 One-way Clutch (AT) 离合器 (AT)	HF0612 AT	S811N724P12	2210002262
 O-Ring O型圈	CO-0517A	S932N421P18	2210002883

上部导丝部

★ 适合[64]MV

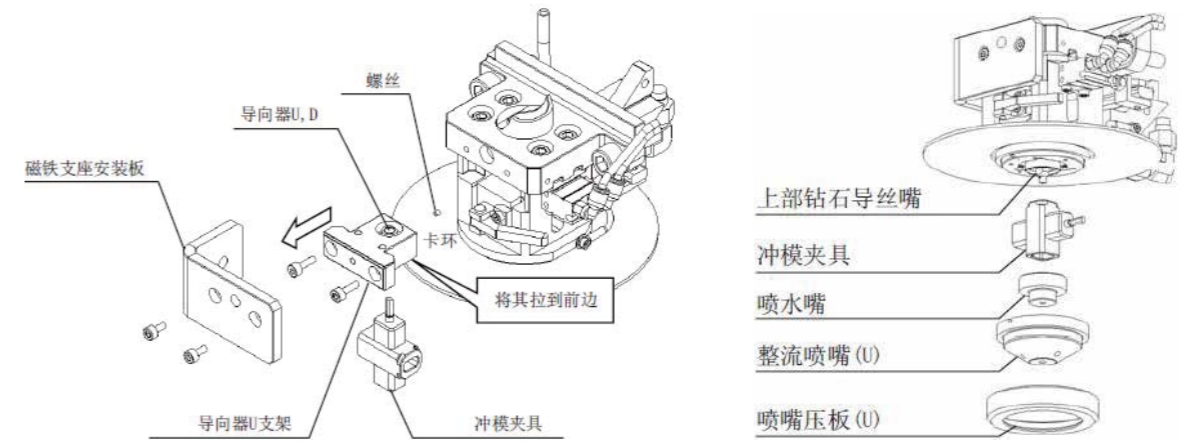

名称	规格	型号	销售代码
 O-Ring O型圈	CO-0515A	S932N421P16	2210002860
 O-Ring O型圈	CO-0534A	S932N421P35	2210000849
 Rectifying Plate(U) 整流筒(U)		X256C475H01	2210003266
 Cable(L=120) 带接头电缆		X654D023G52	2210003904
 Stopper 上机头废丝卷曲树脂滑片		X089D289H01	2210003572

下部导丝部

★ 适合[64]MV

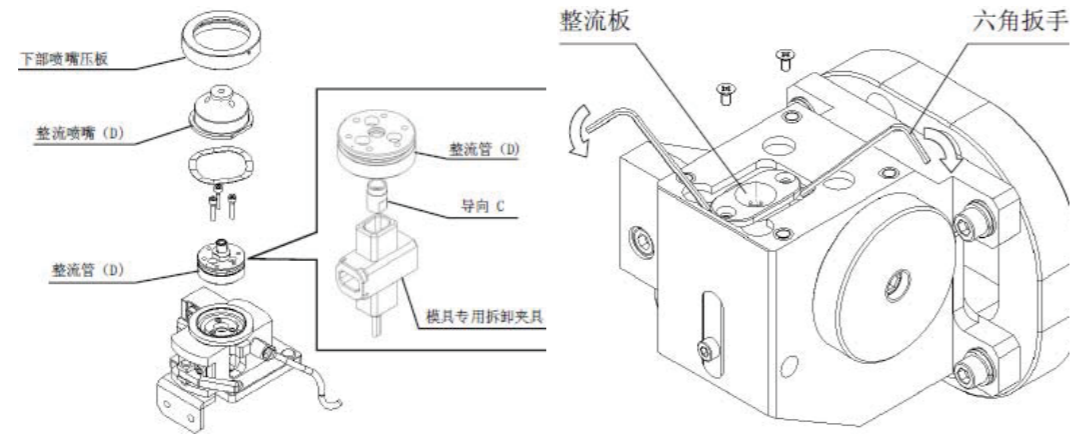

	名称	规格	型号	销售代码
	O-Ring O型圈	CO-0521A *for Lower Flushing Nozzle	S932N421P22	2210002884
	Cylindrical Rectification Tube 整流管(D)		X256C302H01	2210003267
	Compression Spring 整流管(D)固定螺丝		X927D326H01	2210004227
	Round Stick 导电块顶杆		X263D136G53	2210003600
	Bolt 下部导轮固定螺丝	M3X25(SUS)(10PCS)	PACBLT0325	2210003716
	(Hose) Nipple 下机头气管接头	MS-5HLH-4	P648K000P30	2210004878
	O-Ring O型圈	CO-0505A	S932N421P06	2210000863
	Guide C(UD) 导向C		X085C096G53	2210002877
	Guide (UD) 导向器底座		X085C079G53	2210002876
	Lower Roller Block 下机座		X191A803G52	2210002897
	Wire Guide Block (LOWER) 固定座		X191A806G52	2210003277

下部导丝部

★ 适合[64]MV

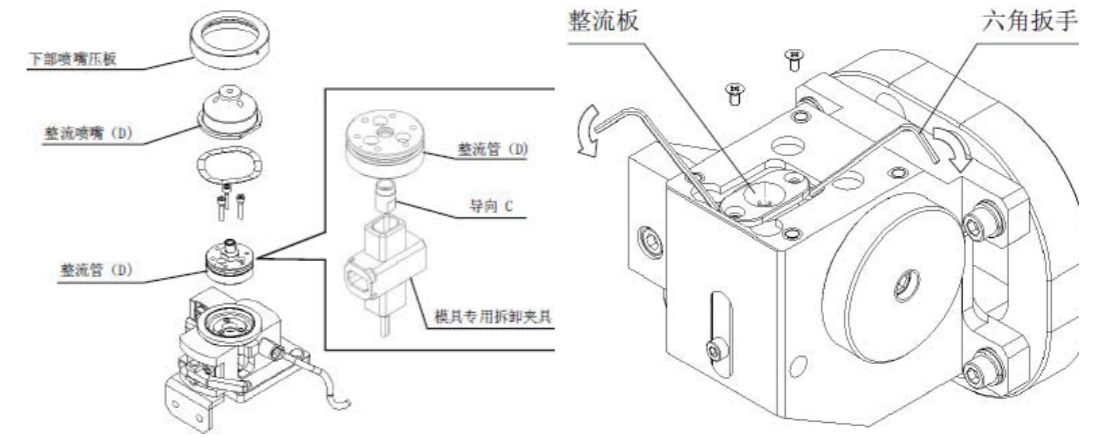

	名称	规格	型号	销售代码
	Lower Nozzle Support 固定座		X265D557H01	2210003681
	Fulcrum Block 固定块		X263D763N51	2210004625
	Lever 支撑杆		X262D713H02	2210003032
	Lower Guide Holder 固定座		X256C312H01	2210003463
	Piping Block 固定座		X263D272H02	2210003464
	Piping Block 固定座		X263D380H02	2210003465
	Wave Washer 波浪垫片		X089D196H01	2210004469
	WG Insulating Plate WG下部绝缘板		X089D225H01	2210002899
	Cover 下部回收整流环	配套o型圈	X085C769H01 P932K004P05 S932N410P12	2210004700 2210004379 2210004380
	NS LOWHEAD BOLT 螺栓		P903K013P88	2210003884

下部导丝部

★ 适合[64]MX

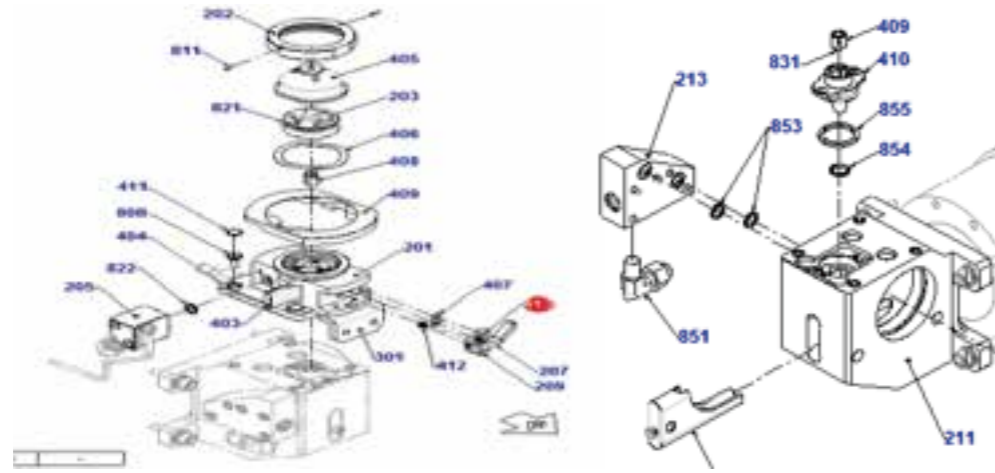



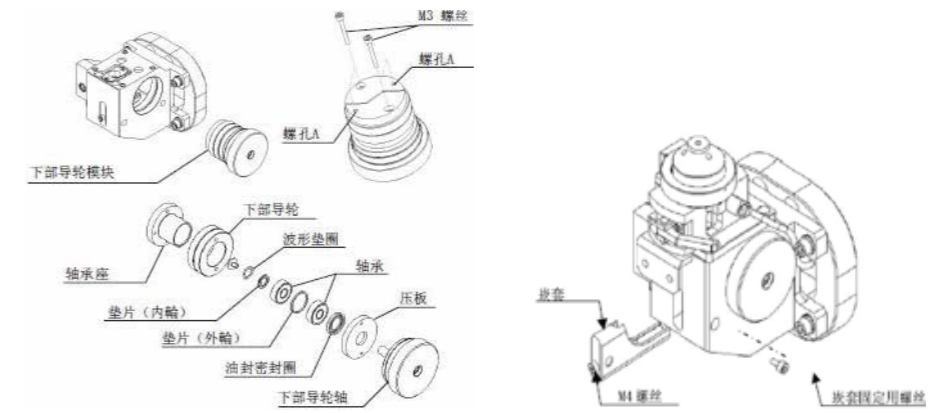

下部轮部

★ 适合[64]MV



	名称	规格	型号	销售代码
	环		X085C426G51	
	GUIDE		X085C079G53	2210002876
	Holder		X052B670H01	DGC0900
	O RING		S932N421P07	DGC0700
	O RING		S932N110P17	DG88600

	名称	规格	型号	销售代码
	Lower Roller 下部导轮		X089D258H02	2210003149
	Oil Seal 油封密封圈	G14X22X3	P932K002P47	2210002887
	Bearing 轴承	608-H-20T1XZZMC3*MA	P840K003P73	2210002886
	Nesting 嵌套		X256C332H01	2210002889
	Wave Washer 波浪垫片		P913K005P73	2210002888
	Shaft 下部导轮轴		X256C414H01	2210003607
	Pipe 收丝管	13.8*11.4-1365	X088D685H30	2210002895
	Pipe 收丝管	13.8*11.4-1745	X088D685H31	2210002896

下部绝缘板

★ 适合[64]MV

名称	规格	型号	销售代码
Insulating Plate (Lower) 绝缘板(下部)		X085C130G51	2210002894

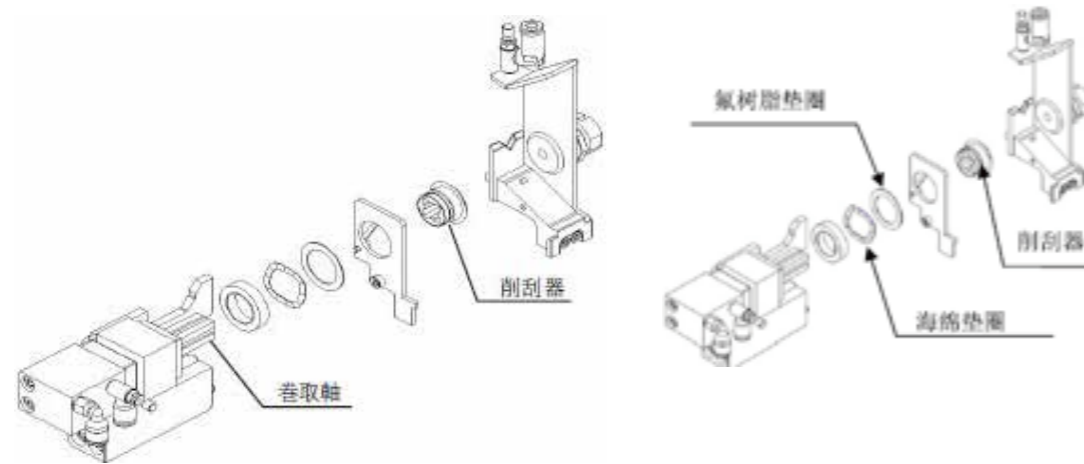

名称	规格	型号	销售代码
Collection Shaft 卷曲轴		X263D435H01	2210002910
Cylinder 气缸	CUJB8-10D	P663K017P97	2210002913
Collection Roller 削刮器		X263D559H01	2210002909
Ptfе Washer 氟树脂垫圈		X089D261H01	2210003393
		X089D289H01	2210003572

丝回收装置 (向上废丝)

★ 适合[64]MV

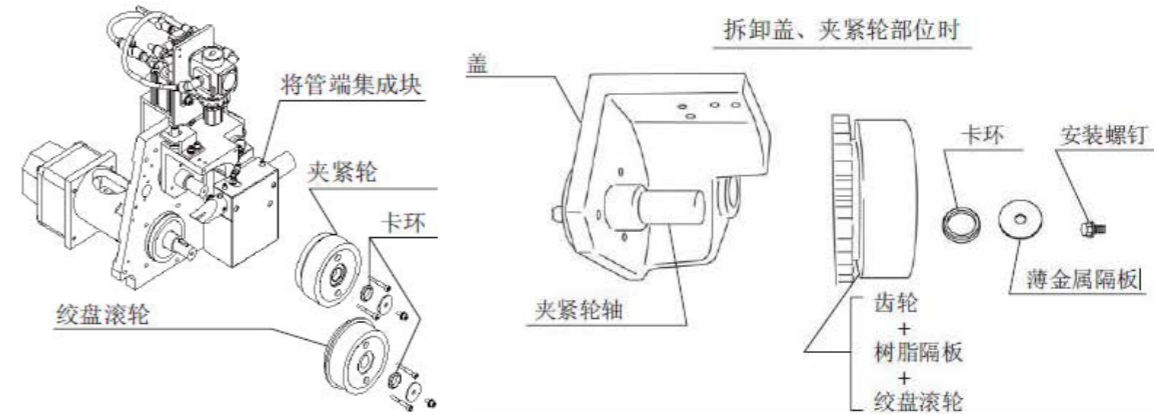





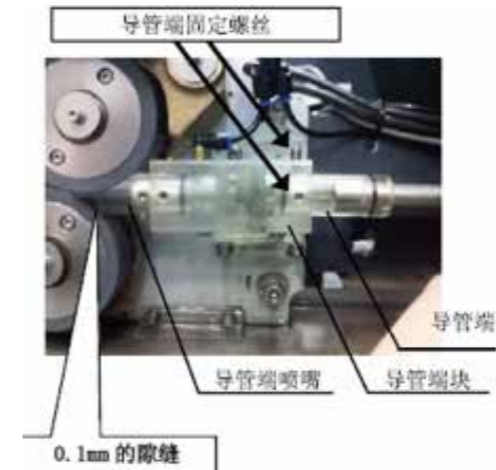
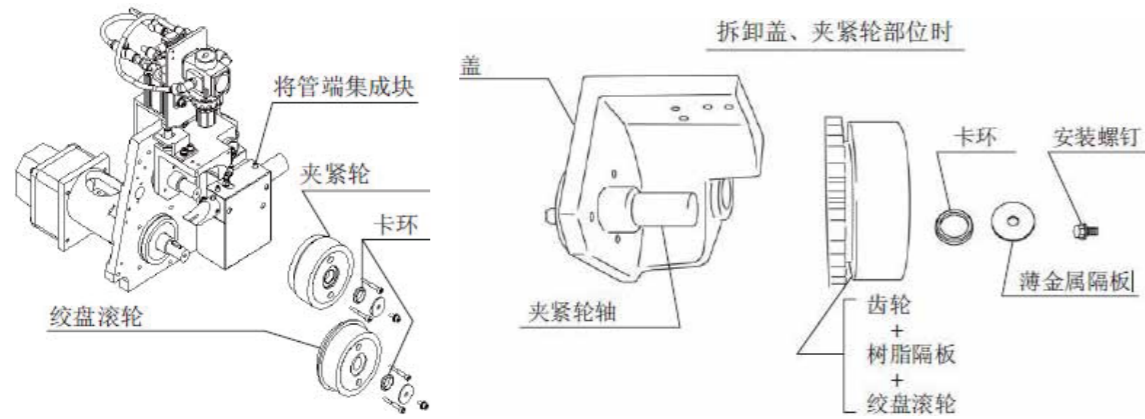

名称	规格	型号	销售代码
Pinch, Wire Collection Roller 丝回收轮(夹侧)		X085C556G51	2210004529
Bearing 轴承(夹侧)	6902-H-20T1XZZ1 *MA NS7S	P840K002P36	2210000203
Collar 树脂隔板		X088D451H01	2210001461
Capstan, Wire Collection Roller 丝回收轮(马达侧)		X085C557G51	2210004530
Bearing 轴承(马达侧)	6204LLUCM/5K	P840K000P25	2210000204
GAER 齿轮		X088D449H02	2210001074

丝回收装置 (向上废丝)

★ 适合[64]MV

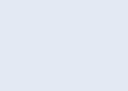

名称	规格	型号	销售代码
 SPACER 塑料垫片		X088D452H02	2210003469
 ROLLER SHAFT 收丝轮轴		X251C159H01	2210004551
 BEARING SPASER(OUTER) 轴承间隔环(外部)		X266D548H01	2210004548
 BEARING SPASER(INNER) 轴承间隔环(内部)		X266D548H02	2210004549
 NUT(FINE U AN04 M20x1) 钢铁制螺母		S891N200P04	2210001544

名称	规格	型号	销售代码
 Pipe End Block 导管端块		X052B641G53	2210004439
		代品X047B745G52	2210005008
 Pipe End Nozzle 导管端喷嘴		X089D465G51	2210003649
		代品X048D272G51	2210004966
 Pipe End 收丝管末管		X089D071H02	2210002906
		代品	DJH5100
 Nozzle 喷嘴	4mm Dia.	X089D206H11	2210002904
 Nozzle 喷嘴	6mm Dia.	X089D206H12	2210002905
 Nozzle 后部喷嘴	3mm Dia.	X089D205H01	2210002907

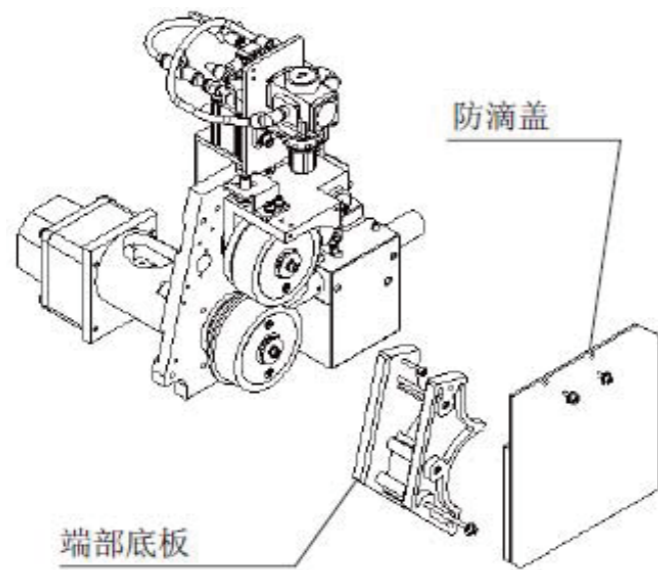

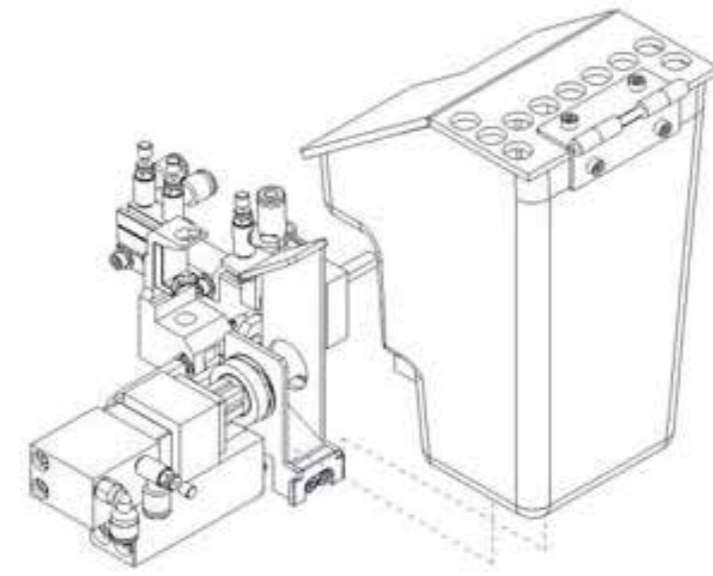

	名称	规格	型号	销售代码
	Waterproof Plate 2 防滴盖		X055C896G51	2210002865
	Roller End Pipe		X088D455H01	2210002861



	名称	规格	型号	销售代码
	Wire Chip Collection Box 废丝回收箱 *标准	真空成形	X052B630H01	2210002890
	Dies Fixture 导丝嘴固定工具 *Supported Angle Master op.		X256C476N51	2210003486
	ROLLERENDPLATE(LEFT) 陶瓷制机床用导轮		X055C787H01	2210002863
	ROLLERENDPLATE(RIGHT) 陶瓷制机床用导轮		X055C786G51	2210002862
	COVER BOARD 固定板		X262D267H01	2210004044
	ROLLER END PIPE 陶瓷制机床用导轮		X088D455H01	2210002861
	BOLT(SUS-ANA M4X75(10PCS)) 螺母		PACBLT0475	2210004042
	WASHER(SUS 4(10PCS)) 垫片		PACZAWS04	2210004047
	WASHER(BANE-WASH 4(SUS)(10pcs)) 垫圈		PACZABS04	2210004043

■ 电池

★ 适合[64]MV

名称	规格			
	名称	规格	零件号	页码
	Lead-Acid Battery 铅蓄电池 *for UPS	PXL12050	P280K000P39	2210003073
	Lithium Cell Battery 锂电池	MR-J3BAT	TN579A950G51	2210003766 X,Y,Z轴伺服控制器电池
	Battery 锂电池	ER6V-C119A	P280K000P68	2210004476 U,V轴伺服控制器电池
	Battery 锂电池	MR- BAT6V1SET	TC350A146G51	2210004887

■ 显示器和键盘膜

★ 适合[64]MV

名称	规格			
	名称	规格	零件号	页码
	Protect Sheet 触摸显示屏膜	PSHEET31 BKO-R9074H02	P965K001P14	2210003499
	Key Board Cover PC键盘罩	PKB-BETU100	P428K001P85	2210000470

■ FA-S Advance系列

名称	规格	型号	销售代码	页
Power Feeder 导电块(上下共用)		X056C075H06	2210000756	4
Diamond Die Guide (U) 导丝嘴(上部)	0.2mm Dia.	X056C833G54	2210000592	3
Diamond Die Guide (L) 导丝嘴(下部)	0.2mm Dia.	X052B387G54	2210000619	3
Guide U 补助导丝骰子(上部)	0.4mm Dia.	X055C763G51	2210000995	16
Guide D 补助导丝骰子(下部)	0.4mm Dia.	X053C884G52	2210000970	21
Flushing Nozzle (U) 加工液喷嘴(上部)	4mm Dia.	X056C836H01	2210000677	5
Flushing Nozzle (L) 加工液喷嘴(下部)	4mm Dia.	X054D881H07	2210000689	5
Jet Nozzle 喷射嘴	1.5mm Dia.	X058D054H02	2210000695	7
O Ring (for Jet nozzle) O型圈(为喷射嘴)	CO-0612A	S932N420P20	2210000848	7
Main-Tension Pinch Roller 主张力夹轮子(胶皮)		X088D350G52	2210000325	8
Brush (for MT Rollers) 刷子(为主张力轮子)		X088D274G51	2210000223	8
Lower Roller 下部轮		X203C607H03	2210000290	26
Bearing for Lower Roller 轴承(为下部轮)		F608-H-VVMC3 (NS7S)	2210002306	26
Wire Collection Roller (Motor side) 丝回收轮(马达侧)		X085C557G51	2210004530	30
Wire Collection Roller (Pinch side) 丝回收轮(夹侧)		X085C556G51	2210004529	30
Bearing (for Wire collection Roller) 轴承(为丝回收轮)		6902-H-20T1XZZ1*MA NS7S	2210000203	30
Filter Element 过滤器	Standard Mesh	Ryoden Filter II	2210004507	40
Filter Element 过滤器	Standard Mesh	Ryoden Filter-R	2210003441	40
Ion Exchange Resin 离子交换树脂	5 Liters/bag	Ryoden Ion	2210002975	41

BA8(制造编码DB#178以后) 和BA24

名称	规格	型号	销售代码	页
Power Feeder 导电块(上下共用)		X088D493H01	2210000763	4
Diamond Die Guide (U) 导丝嘴(上部)	0.2mm Dia.	X056C833G54	2210000592	3
Diamond Die Guide (L) 导丝嘴(下部)	0.2mm Dia.	X052B387G54	2210000619	3
Guide U 补助导丝骰子(上部)	0.4mm Dia.	X055C631G53	2210003565	17
Guide D 补助导丝骰子(下部)	0.4mm Dia.	X055C798G54	2210003082	23
Flushing Nozzle (U) 加工液喷嘴(上部)	4mm Dia.	X056C836H01	2210000677	5
Flushing Nozzle (L) 加工液喷嘴(下部)	4mm Dia.	X054D881H07	2210000689	5
Jet Nozzle 喷射嘴	1.5mm Dia.	X058D054H02	2210000695	7
O Ring (for Jet nozzle) O型圈(为喷射嘴)	CO-0612A	S932N420P20	2210000848	7
Main-Tension Pinch Roller 主张力夹轮子(胶皮)		X088D350G52	2210000325	8
Brush (for MT Rollers) 刷子(为主张力轮子)		X088D274G51	2210000223	8
Lower Roller 下部轮		X203C607H03	2210000290	26
Bearing for Lower Roller 轴承(为下部轮)		F608-H-VVM...	2210002306	26
Wire Collection Roller (Motor side) 丝回收轮(马达侧)		X085C557G51	2210004530	30
Wire Collection Roller (Pinch side) 丝回收轮(夹侧)		X085C556G51	2210004529	30
Bearing (for Wire Collection Roller) 轴承(为丝回收轮)		6902-H-20T1...	2210000203	30
Filter Element 过滤器	Standard Mesh	Ryoden Filter II	2210004507	40
Filter Element 过滤器	Standard Mesh	Ryoden Filter-R	2210003441	40
Ion Exchange Resin 离子交换树脂	5 Liters/bag	Ryoden Ion	2210002975	41

BA8(制造编码DB#1-177)

名称	规格	型号	销售代码	页
Power Feeder 导电块(上下共用)		X088D493H02	2210000763	4
Diamond Die Guide (U) 导丝嘴(上部)	0.2mm Dia.	X056C833G54	2210000592	3
Diamond Die Guide (L) 导丝嘴(下部)	0.2mm Dia.	X052B387G54	2210000619	3
Guide U 补助导丝骰子(上部)	0.4mm Dia.	X055C631G52	2210000994	19
Guide D 补助导丝骰子(下部)	0.4mm Dia.	X055C630G54	2210000992	24
Flushing Nozzle (U) 加工液喷嘴(上部)	4mm Dia.	X056C836H01	2210000677	5
Flushing Nozzle (L) 加工液喷嘴(下部)	4mm Dia.	X054D881H07	2210000689	5
Jet Nozzle 喷射嘴	1.5mm Dia.	X058D054H02	2210000695	7
O Ring (for Jet nozzle) O型圈(为喷射嘴)	CO-0612A	S932N420P20	2210000848	7
Main-Tension Pinch Roller 主张力夹轮子(胶皮)		X088D350G52	2210000325	8
Brush (for MT Rollers) 刷子(为主张力轮子)		X088D274G51	2210000223	8
Lower Roller 下部轮		X203C607H03	2210000290	26
Bearing for Lower Roller 轴承(为下部轮)		F608-H-VVM...	2210002306	26
Wire Collection Roller (Motor side) 丝回收轮(马达侧)		X085C557G51	2210004530	30
Wire Collection Roller (Pinch side) 丝回收轮(夹侧)		X085C556G51	2210004529	30
Bearing (for Wire Collection Roller) 轴承(为丝回收轮)		6902-H-20T1...	2210000203	30
Filter Element 过滤器	Standard Mesh	Ryoden Filter II	2210004507	40
Filter Element 过滤器	Standard Mesh	Ryoden Filter-R	2210003441	40
Ion Exchange Resin 离子交换树脂	5 Liters/bag	Ryoden Ion	2210002975	41

FA-S系列

名称	规格	型号	销售代码	页
Power Feeder 导电块(上下共用)		X056C075H06	2210000756	4
Diamond Die Guide (U) 导丝嘴(上部)	0.2mm Dia.	X056C833G54	2210000592	3
Diamond Die Guide (L) 导丝嘴(下部)	0.2mm Dia.	X052B387G54	2210000619	3
Guide U 补助导丝骰子(上部)	0.4mm Dia.	X055C763G51	2210000995	16
Guide D 补助导丝骰子(下部)	0.4mm Dia.	X053C884G52	2210000970	21
Flushing Nozzle (U) 加工液喷嘴(上部)	4mm Dia.	X056C836H01	2210000677	5
Flushing Nozzle (L) 加工液喷嘴(下部)	4mm Dia.	X054D881H07	2210000689	5
Jet Nozzle 喷射嘴	1.5mm Dia.	X058D054H02	2210000695	7
O Ring (for Jet nozzle) O型圈(为喷射嘴)	CO-0612A	S932N420P20	2210000848	7
Main-Tension Pinch Roller 主张力夹轮子(胶皮)		X088D350G52	2210000325	8
Brush (for MT Rollers) 刷子(为主张力轮子)		X088D274G51	2210000223	8
Lower Roller 下部轮		X203C607H03	2210000290	26
Bearing for Lower Roller 轴承(为下部轮)		F608-H-VVM...	2210002306	26
Wire Collection Roller (Motor side) 丝回收轮(马达侧)		X055C009G51	2210000299	32
Wire Collection Roller (Pinch side) 丝回收轮(夹侧)		X055C008G51	2210000300	32
Bearing (for Wire collection Roller) 轴承(为丝回收轮)		DDRF-1980DDR	2210002271	32
Filter Element 过滤器	Standard Mesh	Ryoden Filter II	2210004507	40
Filter Element 过滤器	Standard Mesh	Ryoden Filter-R	2210003441	40
Ion Exchange Resin 离子交换树脂	5 Liters/bag	Ryoden Ion	2210002975	41

PA05S

名称	规格	型号	销售代码	页
Power Feeder (Cylindrical type) 导电块(上下共用)		X054D476H01	2210000768	4
Power Feeder (Index type) 导电块(上下共用)		X056C075H06	2210000756	4
Diamond Die Guide (U) 导丝嘴(上部)	0.1mm Dia.	X056C412G55	2210002234	3
Diamond Die Guide (L) 导丝嘴(下部)为导电块	0.1mm Dia.	X052B346G51	2210000626	3
Diamond Die Guide (L) 导丝嘴(下部)为导电块	0.1mm Dia.	X052B243G63	2210000611	3
Guide U 补助导丝骰子(上部)	0.4mm Dia.	X055C424G51	2210000993	20
Guide D 补助导丝骰子(下部)	0.4mm Dia.	X055C478G51	2210002933	25
Flushing Nozzle (U) 加工液喷嘴(上部)	4mm Dia.	X203C929H01	2210000679	6
Flushing Nozzle (L) 加工液喷嘴(下部)	4mm Dia.	X054D881H07	2210000689	5
Zinc Cap (U) 锌盖子(上部)	4mm Dia.	X264D883H01	2210000720	6
Zinc Plate (D) 锌盖子(下部)		X259D536H01	2210000718	6
Jet Nozzle 喷射嘴	0.75mm Dia.	X054D826H07	2210000697	7
O Ring (for Jet nozzle) O型圈(为喷射嘴)	CO-0612A	S932N420P20	2210000848	7
Main-Tension Pinch Roller 主张力夹轮子(胶皮)		X088D350G52	2210000325	8
Wire Collection Roller (Motor side) 丝回收轮		X058D339G51	2210000288	37
Bearing (for Wire collection Roller) 轴承(为丝回收轮)		P840K000P25	2210000204	34
Filter Element 过滤器	Standard Mesh	Ryoden Filter II	2210002974	40
Filter Element 过滤器	Standard Mesh	Ryoden Filter-R	2210003441	40
Ion Exchange Resin 离子交换树脂	5 Liters/bag	Ryoden Ion	2210002975	41

RA90AT

名称	规格	型号	销售代码	页
Power Feeder 导电块(上下共用)		X056C075H06	2210000756	4
Diamond Die Guide (U) 导丝嘴(上部)	0.2mm Dia.	X056C833G54	2210000592	3
Diamond Die Guide (L) 导丝嘴(下部)	0.2mm Dia.	X052B387G54	2210000619	3
Guide U 补助导丝骰子(上部)	0.4mm Dia.	X055C763G51	2210000995	16
Guide D 补助导丝骰子(下部)	0.4mm Dia.	X053C884G52	2210000970	21
Flushing Nozzle (U) 加工液喷嘴(上部)	4mm Dia.	X056C836H01	2210000677	5
Flushing Nozzle (L) 加工液喷嘴(下部)	4mm Dia.	X054D881H07	2210000689	5
Jet Nozzle 喷射嘴	1.5mm Dia.	X058D054H02	2210000695	7
O Ring (for Jet nozzle) O型圈(为喷射嘴)	CO-0612A	S932N420P20	2210000848	7
Main-Tension Pinch Roller 主张力夹轮子(胶皮)		X088D350G52	2210000325	8
Lower Roller 下部轮		X203C607H03	2210000290	26
Bearing for Lower Roller 轴承(为下部轮)		F608-H-VVM...	2210002306	26
Wire Collection Roller (Motor side) 丝回收轮(马达侧)		X058D339G51	2210000288	37
Wire Collection Roller (Pinch side) 丝回收轮(夹侧)		X058D340G51	2210000287	37
Bearing (for Wire collection Roller) 轴承(为丝回收轮)		DDRF-1980DDR	2210002271	37
Filter Element 过滤器	Standard Mesh	Ryoden Filter II	2210004507	40
Filter Element 过滤器	Standard Mesh	Ryoden Filter-R	2210003441	40
Ion Exchange Resin 离子交换树脂	5 Liters/bag	Ryoden Ion	2210002975	41

MV系列

名称	规格	型号	销售代码	页
Power Feeder 导电块(上下共用)		X089D256H01	2210003148	47
Diamond Die Guide (U) 导丝嘴(上部)	0.2mm Dia.	X052B662G63	2210004008	46
Diamond Die Guide (L) 导丝嘴(下部)	0.2mm Dia.	X052B663G63	2210004009	46
Flushing Nozzle (U) 加工液喷嘴(上部)	4mm Dia.	X085C257H01	2210003568	52
Flushing Nozzle (L) 加工液喷嘴(下部)	4mm Dia.	X085C131H11	2210003328	47
Jet Nozzle 喷射嘴	1.5mm Dia.	X089D279H01	2210002882	48
O Ring (for Jet nozzle) O型圈(为喷射嘴)	CO-0517A *NOK	S932N421P18	2210002883	52
Main-Tension Pinch Roller 主张力夹轮子(胶皮)		X088D301H04	2210004711	49
Bearing 轴承	DDRF-1980DDR	P0P25LY121	2210002271	49
Wire Collection Roller (Pinch side) 丝回收轮(夹侧)		X085C556G51	2210004529	59
Wire Collection Roller (Motor side) 丝回收轮(马达侧)		X085C557G51	2210004530	59
Bearing (for Wire collection Roller) 轴承(为丝回收轮)	6902-H-20T1XZZ1* MANS7S		2210000203	59
Filter Element 过滤器	Standard Mesh	Ryoden Filter II	2210004507	40
Filter Element 过滤器	Standard Mesh	Ryoden Filter-R	2210003441	40
Ion Exchange Resin 离子交换树脂	5 Liters/bag	Ryoden Ion	2210002975	41

FUTURE MANUFACTURING

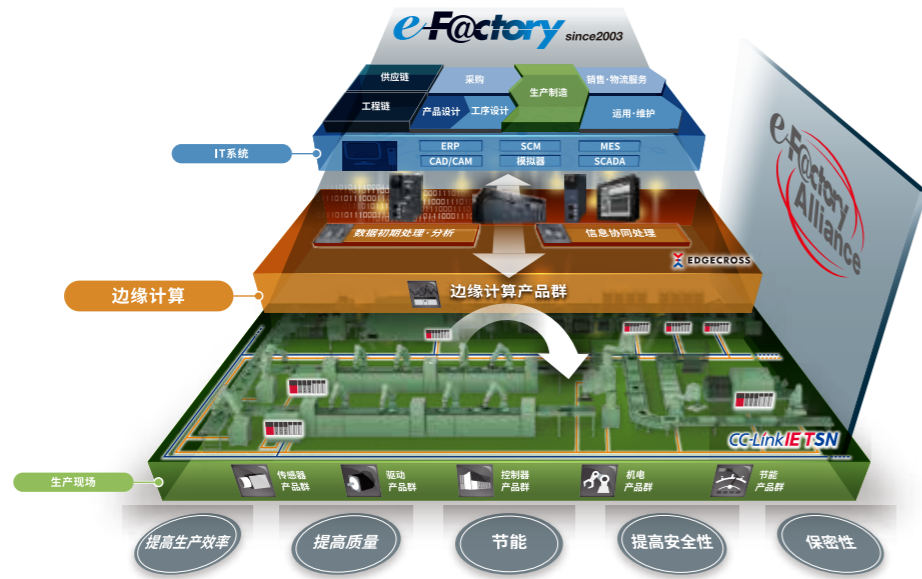

三菱电机e-F@ctory设想未来制造业：“制造”在环境变化和启用IoT的世界中进化。

自2003年成立以来，e-F@ctory打造了Kaizen^{#1}自动化解决方案，有助于优化和管理日益复杂的工厂“制造”业。随着自身的发展壮大，不仅广泛应用于IT领域，也带来了“网络虚拟世界”的分析效益，模拟与工程虚拟，同时也对“物理”世界提出了更高的要求，以增强数据感知、收集信息和通信交流。

e-F@ctory的持续发展和成功完全取决于厂商们的理解和支持，因为每家厂商都有各自必须兑现的需求和投资方案；诸如“减少管理成本”（TCO）；生产的灵活性与产品的多样化；不断提高产品质量。

总之，e-F@ctory的目标就是为厂商“超越时代”提供经营工具，同时使制造业能够适应环境地发展。要做到这一点，有三个要素：

· e-F@ctory Alliance 合作伙伴：提供广泛的软件、设备和系统构建，优化 e-F@ctory 构筑。

· 先进的通信：利用开放的网络技术如 CC-Link IE 以及 OPC 通信协议，打开设备数据的大门，包括支持高速提取的遗留系统。

· 平台思维：减少复杂的接口，以便汇总机器人、运动、开放编程语言（C 语言）、PAC（可编程自动化控制器）等，加强控制领域，强化工业操作硬件。

Kaizen^{#1} = 改善
TCO = 总体拥有成本 (管理成本)



YOUR SOLUTION PARTNER



三菱电机可提供从控制、驱动产品到数控、加工机、工业机器人等广泛的自动化设备。

可信赖的品牌

自1870年创立以来，“三菱”的名字就被金融、商业、工业领域大约45家企业作为公司名称的一部分使用。

时至今日，“三菱”这个品牌作为高品质的象征驰名世界。

三菱电机株式会社在宇宙开发、运输、半导体、能源系统、信息通信处理、AV设备和家电、建筑、能源管理、自动化系统领域开展业务，在140个国家和地区拥有183家工厂和研究所。

为什么说“三菱电机的自动化解决方案可以信赖”呢？这正是因为可靠、高效、易用的自动化设备和控制装置，首先都在我们自己的工厂里使用并经过验证。

作为一个销售额4兆日元（400亿美元以上）、拥有146,000多名员工的世界五百强企业之一，三菱电机不仅可以提供高品质的产品，而且还可以提供高水平的服务和技术支持。



低压配电控制设备：MCCB、MCB、ACB



变压器·高压配电控制机器



电力仪表·节能管理支援产品



电源·环境周边设备(产业用鼓风机, UPS)



可编程控制器 (PLC)



变频调速器 (INV)、伺服系统 (SV)



人机界面 (HMI)



边缘计算产品



数控系统 (CNC)



工业机器人 (Robot)



加工机：放电加工机、激光加工机、激光打孔机

※向各国提供的产品不同。

Global Partner. Local Friend.

上海 上海市虹桥路1386号 三菱电机自动化中心 200336 电话: 86-21-2322-3030 传真: 86-21-2322-3000	武汉 武汉市江汉区云霞路187号泛海国际中心 A单元904B室 430022 电话: 86-27-8555-8043 传真: 86-27-8555-7883	无锡 无锡市南长区运河东路557号B栋2221室 214021 电话: 86-510-8512-6335 传真: 86-512-8512-1335
苏州 苏州市苏州工业园区苏州中心办公楼C座 06层601、608室 215021 电话: 86-512-6258-8830	常熟 江苏常熟高新技术产业开发区黄浦江路133号 215533	宁波 浙江省宁波市海曙区南站东路16号 月湖银座大厦612-613室 315000 电话: 86-574-8730-0815
合肥 合肥市蜀山区潜山路888号合肥百利商务中心 1号楼1408室 230000 电话: 86-551-6515-1300	青岛 青岛市高新区科海路333号 办公楼一楼 266000 电话: 86-532-8790-5028	

深圳 深圳市龙岗区雅宝路1号星河WORLD B栋 大厦8层 518129 电话: 86-755-2399-8272 传真: 86-755-8218-4776	广州 广州市番禺区钟村街汉溪大道东276-282号 时代E-PARK A1栋1006 510030 电话: 86-20-8923-6730 传真: 86-20-8923-6715	东莞 东莞市长安镇锦厦路段振安大道聚和国际 机械五金城C308室 523859 电话: 86-769-8547-9675 传真: 86-769-8535-9682
厦门 厦门市湖里区高崎南五路212号 中骏大厦第三座304单元 361015 电话: 86-592-5728-130	长沙 长沙市岳麓区环湖路1177号 金茂广场南塔1718室 410205 电话: 86-731-8229-0957	

北京 北京市朝阳区酒仙桥路20号颐堤港一座 第5层504-506单元 100016 电话: 86-10-6518-8830 传真: 86-10-6518-8030	天津 天津市河西区友谊路35号城市大厦 3203室、3204B室 300061 电话: 86-22-2813-1015 传真: 86-22-2813-1017	西安 西安市雁塔区二环南路88号 老三届·世纪星大厦24层D-E室 710065 电话: 86-29-8730-5236 传真: 86-29-8730-5235
沈阳 沈阳市和平区和平大街69号总统大厦 C座2302室 110003 电话: 86-24-2259-8830 传真: 86-24-2259-8030	大连 大连市经济技术开发区东北区三街5号 116600 电话: 86-411-8765-5951 传真: 86-411-8765-5952	郑州 郑州市金水区文化路68号数码港1016室 450002 电话: 86-371-6913-6201 传真: 86-371-6913-6201

重庆 重庆市九龙坡区(县)石杨路18号 江夏星光汇1幢0-办公4 400039 电话: 86-023-6816-2680	成都 成都市青羊区光华北三路98号光华中心C栋 15楼1501-1502号 610074 电话: 86-28-8446-8030 传真: 86-28-8446-8630	
--	---	--



三菱电机自动化(中国)有限公司

上海市虹桥路1386号 三菱电机自动化中心 200336
 No.1386 Hongqiao Road, Mitsubishi Electric Automation Center, Shanghai, China, 200336
 电话: 86-21-2322-3030 传真: 86-21-2322-3000
 官网: <https://www.MitsubishiElectric-FA.cn> 技术支持热线: 400-821-3030